

Pioneer *sound.vision.soul*

High power HDD/CD player with “Memory Stick”
and FM/AM tuner

Lecteur de disque dur/CD, “Puissance élevée”, avec
“Memory Stick” et syntoniseur FM/AM



SUPER TUNER III

Operation Manual

DEH-P90HDD

Mode d'emploi

ENGLISH

FRANÇAIS

Dear Customer	4	Built-in CD Player	19
Key Finder	5	Display and indicators	19
Before Using This Product	6	Basic operation	19
Features	6	Switching and scrolling the title	20
About this product	7	Built-in CD player function menu	20
About this manual	7	Repeating play	20
Important	7	Playing tracks in random order	21
Precaution	7	Scanning tracks of a CD	21
After-sales service for Pioneer products	8	Selecting tracks from the track title list	21
About the XM READY mark	8	Pausing CD playback	22
Resetting the microprocessor	9	Entering disc titles	22
About the demo modes	9	MP3 Play	23
About basic displays	9	Display and indicators	23
Remote controller and care	10	Basic operation	23
Using the steering remote controller	11	Switching and scrolling the title	24
Displaying and setting the clock	12	MP3 function menu	24
Detaching and replacing the front panel	13	Repeating play	24
Basic Operation	14	Playing tracks in random order	25
Turning a source on or off	14	Scanning folders and tracks	25
SOFT KEY operation	14	Selecting tracks from the track title list	26
Key guidance indicator	16	Pausing MP3 playback	26
Tuner	17	Music Server Recording	27
Display and indicators	17	Display and indicators	27
Basic operation	17	Before recording	27
Storing and recalling broadcast stations	17	Recording from the built-in CD	28
Tuner function menu	18	Switching CD information	29
Storing the strongest broadcast stations	18	Recording from a source other than the built-in CD	29
Selecting stations from the preset channel list	18	Recording function menu	29
Tuning in strong signals	18	Selecting the recording range	30
		Selecting the recording quality	30

Music Server Play 31

Display and indicators	31
Basic operation	31
Selecting the playlist mode	31
Using the custom playlist mode	32
Switching and scrolling the title	33
Music server function menu	34
Repeating play	34
Playing tracks in random order	34
Scanning files and tracks	34
Selecting tracks from the track title list	35
Selecting files from the playlist file title list	35
Pausing music server playback	35
Entering titles	36
Selecting the playlist mode	37
Deleting tracks and track information	37

“Memory Stick” Player 39

Display and indicators	39
Basic operation	39
Switching and scrolling the title	40
“Memory Stick” player function menu	40
Repeating play	40
Playing tracks in random order	40
Scanning tracks of a “Memory Stick”	41
Selecting tracks from the track title list	41
Pausing “Memory Stick” playback	41
Erasing tracks from the “Memory Stick”	42

Multi-CD Player 43

Display and indicators	43
50-disc multi-CD player	43
Basic operation	43
Selecting a disc directly	43
Switching and scrolling the title	44
Multi-CD player function menu	44
Repeating play	44
Playing tracks in random order	45
Scanning CDs and tracks	45
Selecting tracks from the track title list	45
Selecting discs from the disc title list	46
Pausing CD playback	46
Entering disc titles	46
Using compression and dynamic bass emphasis	47
Using ITS memory	47

DAB Tuner 49

Display and indicators	49
Basic operation	49
Storing and recalling services	50
Changing band	50
Switching the display	50
Switching the road traffic flash and transport flash on or off	50
Dynamic label function	51
DAB tuner function menu	51
Setting the announcement support interruption	52
Selecting services from the preset service list	52
Selecting services from the available service list	52
Searching the available PTY	52

TV Tuner	53	Initial Settings	64
Display and indicators	53	Initial settings menu	64
Basic operation	53	Using reverse mode	64
Storing and recalling broadcast stations	53	Using the feature demo	64
Changing band	54	Switching the auxiliary setting	64
TV tuner function menu	54	Switching the telephone muting/attenuation setting	65
Selecting channels from the preset channel list	54	Formatting the “Memory Stick”	65
		Setting the warning tone	66
Audio Adjustments	55	Other Functions	67
Adjusting the audio easily	55	Attenuating volume	67
Adjusting the audio finely	55	Changing the display form	67
Extra functions	55	Adjusting the brightness	67
Recalling equalizer curves	55	Switching the dimmer setting	67
Audio menu	56	Selecting the wall paper pattern	67
Using balance adjustment	56	Setting the entertainment display	67
Using loudness	56	Using the AUX source	69
Using sound field control, octaver and BBE® sound	56	Using the telephone muting/ attenuation	69
Adjusting equalizer curves	57	Additional Information	70
Adjusting 13-band graphic equalizer	57	CD player and care	70
Using automatic sound levelizer	58	MP3 files	71
Using position selector	58	“Memory Stick” player and care	72
Using time alignment	59	Understanding auto-equalizing error messages	73
Using subwoofer output	59	Understanding built-in CD player error messages	74
Using the high pass filter	60	Understanding music server error messages	75
Adjusting source levels	61	Understanding music server error messages when recording	76
Using the auto-equalizer	61	Understanding “Memory Stick” player error messages	77
Switching the digital attenuator	61	Terms	79
Creating the auto-equalizer curve	61	Specifications	81



Dear Customer:

Selecting fine audio equipment such as the unit you've just purchased is only the start of your musical enjoyment. Now it's time to consider how you can maximize the fun and excitement your equipment offers. This manufacturer and the Electronic Industries Association's Consumer Electronics Group want you to get the most out of your equipment by playing it at a safe level. One that lets the sound come through loud and clear without annoying blaring or distortion—and, most importantly, without affecting your sensitive hearing.

Sound can be deceiving. Over time your hearing "comfort level" adapts to higher volumes of sound. So what sounds "normal" can actually be loud and harmful to your hearing. Guard against this by setting your equipment at a safe level BEFORE your hearing adapts.

To establish a safe level:

- Start your volume control at a low setting.
- Slowly increase the sound until you can hear it comfortably and clearly, and without distortion.

Once you have established a comfortable sound level:

- Set the dial and leave it there.

Taking a minute to do this now will help to prevent hearing damage or loss in the future. After all, we want you listening for a lifetime.

We Want You Listening For A Lifetime

Used wisely, your new sound equipment will provide a lifetime of fun and enjoyment. Since hearing damage from loud noise is often undetectable until it is too late, this manufacturer and the Electronic Industries Association's Consumer Electronics Group recommend you avoid prolonged exposure to excessive noise. This list of sound levels is included for your protection.

Decibel

Level	Example
-------	---------

30	Quiet library, soft whispers
40	Living room, refrigerator, bedroom away from traffic
50	Light traffic, normal conversation, quiet office
60	Air conditioner at 20 feet, sewing machine
70	Vacuum cleaner, hair dryer, noisy restaurant
80	Average city traffic, garbage disposals, alarm clock at two feet.

THE FOLLOWING NOISES CAN BE DANGEROUS UNDER CONSTANT EXPOSURE

90	Subway, motorcycle, truck traffic, lawn mower
100	Garbage truck, chain saw, pneumatic drill
120	Rock band concert in front of speakers, thunderclap
140	Gunshot blast, jet plane
180	Rocket launching pad

Information courtesy of the Deafness Research Foundation.



Head unit

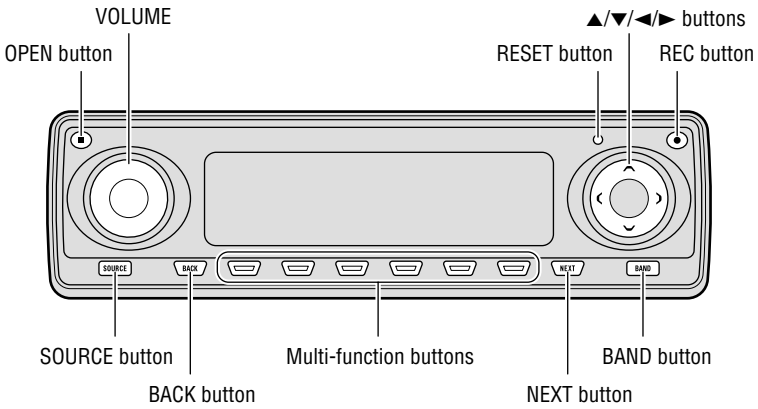

Steering remote controller

A steering remote controller that enables remote operation of the head unit is supplied. Operation is the same as when using buttons on the head unit.

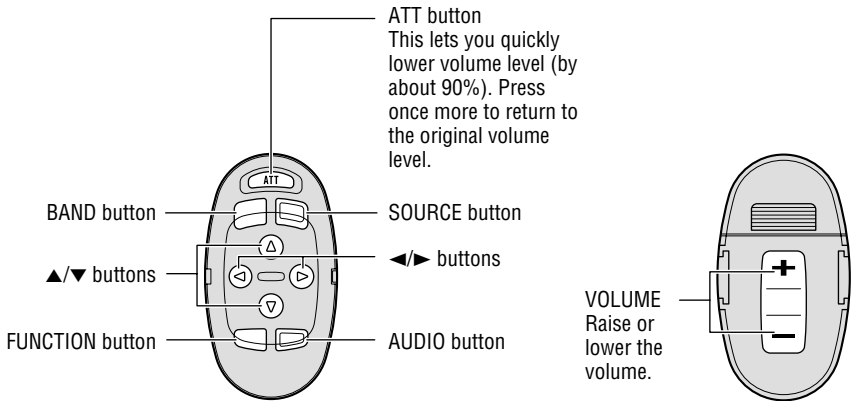

Features

Music server

You can record music from the built-in CD player or from other audio devices and play them back on the music server. You can also organize and edit favorite tracks, etc.

Automatic title retrieval function using Gracenote CDDB (for encoding only)

When music is recorded on the music server from the built-in CD, information such as the recording artist and track name is retrieved from the Gracenote CDDB database and displayed. (See page 33.)

Time stamp function

When recording music on the music server, it is possible to add a recording date to the music data automatically using this product's clock or calendar. **(Please set the time and date before using this product.)** (See page 12.)

“Memory Stick” player

The “MagicGate Memory Stick” can be used for playback.

CD playback

It is possible to play back music stored on CD/CD-R/CD-RW formats.

MP3 file playback

It is possible to play back MP3 files recorded on CD-ROM/CD-R/CD-RW discs (recordings complying with ISO9660 Level 1/Level 2 standards). Correspondence to extended format is made with the following conditions.

Joliet: Correspondence only to the 8.3 format.

Romeo: Correspondence to folder names with up to 64 characters and file names with up to 63 characters (including the extension).

(See page 79.)

DSP functions

The audio feel of actually being at the music venue is recreated by means of such functions as the “Auto Equalizer”, which measures passenger cabin audio characteristics and automatically compensates to optimize sound quality, and the “Time Alignment Function”, which achieves clear sound image positioning.

When recording please pay attention to these points:

- Please may test recordings of recordings that can not be taken again.
- We cannot accept liability for data not recorded or lost due to the failure, improper operation or malfunction of this product.
- The use of recordings for purposes other than personal enjoyment, etc. are not permitted if they infringe copyrights and the rights of copyright claimants without prior consent.

Note:

- “MagicGate”, “MagicGate Memory Stick”, “Memory Stick” and their respective logos are the registered trademarks of Sony Corp.
- Windows is a brand name and the trademark of the Microsoft Corporation in the US, North America and other countries.

About this product

The tuner frequencies on this product are allocated for use in North America. Use in other areas may result in improper reception.

Products with voice control functions

This product's "Memory Stick" and the music server have no voice control functions. Tracks recorded on the music server can not be called up by means of voice recognition.

About this manual

This product features a number of sophisticated functions ensuring superior reception and operation. All are designed for the easiest possible use, but many are not self-explanatory. This operation manual is intended to help you benefit fully from their potential and to maximize your listening enjoyment.

We recommend that you familiarize yourself with the functions and their operation by reading through the manual before you use this product. It is especially important that you read and observe the "Precaution" on this page and in other sections.

This manual explains head unit operation. You can perform the same operations with the steering remote controller.

Important

The serial number of this device is located on the bottom of this product. For your own security and convenience, be sure to record this number on the enclosed warranty card.

Precaution

CAUTION: USE OF CONTROL OR ADJUSTMENT OR PERFORMANCE OF PROCEDURES OTHER THAN THOSE SPECIFIED HEREIN MAY RESULT IN HAZARDOUS RADIATION EXPOSURE.

CAUTION: THE USE OF OPTICAL INSTRUMENTS WITH THIS PRODUCT WILL INCREASE EYE HAZARD.

- Keep this manual handy as a reference for operating procedures and precautions.
- Always keep the volume low enough for outside sounds to be audible.
- Protect the product from moisture.
- If the battery is disconnected, the preset memory will be erased and must be reprogrammed.

After-sales service for Pioneer products

Please contact the dealer or distributor from where you purchased the product for its after-sales service (including warranty conditions) or any other information. In case the necessary information is not available, please contact the companies listed below:

Please do not ship your product to the companies at the addresses listed below for repair without advance contact.

U.S.A.

Pioneer Electronics (USA) Inc.
CUSTOMER SUPPORT DIVISION
P.O. Box 1760
Long Beach, CA 90801-1760
800-421-1404

CANADA

Pioneer Electronics of Canada, Inc.
CUSTOMER SATISFACTION DEPARTMENT
300 Allstate Parkway
Markham, Ontario L3R 0P2
(905) 479-4411
1-877-283-5901

For warranty information please see the Limited Warranty sheet included with your product.

- When having this product serviced or repaired, data you have recorded may be lost. Because of the specifications of this product, there can be no compensation for the contents of the recorded data. Please be aware of this beforehand.
- There can be no compensation for recorded data damaged or lost because of troubles or defects of this product. (At present, there is no correspondence to backup or repair of music data.)
- This product does not support additional hard disk installation or hard disk exchange by the customer.

About the XM READY mark



The "XM READY" mark printed on the front panel of this product indicates that the Pioneer XM tuner (sold separately) can be controlled using this product.

Please inquire of your dealer or nearest authorized Pioneer service station regarding the XM tuner that can be connected to this product. For operation of the XM tuner, refer to the XM tuner owner's manual.

Note:

- The XM Satellite Radio is developing a new band of radio in the U.S.A.



The system will use direct satellite-to-receiver broadcasting technology to provide listeners in their cars and at home with crystal-clear sound seamlessly from coast to coast. XM will create and package up to 100 channels of digital-quality music, news, sports, talk and children's programming.

- When this product is connected to the XM tuner, only one external unit can be connected. (Refer to page 14.)

Resetting the microprocessor

The microprocessor must be reset under the following conditions:

When using this product for the first time after installation.

When the machine fails to operate properly.

When strange (incorrect) messages appear on the display.

- To reset the microprocessor, press **RESET** on the head unit with a pen tip or other pointed instrument.

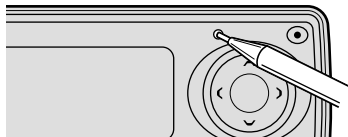

Precaution:

- After resetting, please set the time and date (see page 12). If the time and date are not set correctly, the music server and the "Memory Stick" may not operate correctly.

Note:

- The recorded contents of the music server are erased when the RESET button is pressed.

About the demo modes

This product features two demonstration modes. One is the reverse mode and the other is the feature demo mode.

Reverse mode

If you do not carry out an operation within about 30 seconds, screen indications will start to reverse, and then continue reversing every 10 seconds. Pressing the button 5 when power to this product is switched off while the ignition switch is set to ACC or ON cancels the reverse mode. Press the button 5 again to start the reverse mode.

Feature demo

The feature demo automatically starts when power to this product is switched off while the ignition switch is set to ACC or ON. Pressing the button 6 during feature demo operation cancels the feature demo mode. Press the button 6 again to start the feature demo mode.

Remember that if the feature demo continues operating when the car engine is switched OFF, it may drain battery power.

Note:

- The red lead (ACC) of this product should be connected to a terminal coupled with ignition switch ON or OFF operations. If this is not done, the vehicle battery may be drained.
- When the source is off, you can check the location of "5" and "6" by turning on the feature demo.



About basic displays

This product is equipped with two forms of basic display. You can select the desired display.

FORM 1



FORM 2



Note:

- For details, refer to "Changing the display form" on page 67.

Remote controller and care

Installing the lithium battery

- Remove the cover on the back of the steering remote controller and insert the battery with the (+) and (-) poles pointing in the proper direction.

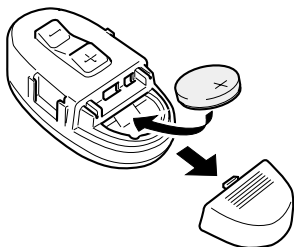

Replacing the lithium battery

- Remove the lithium battery.

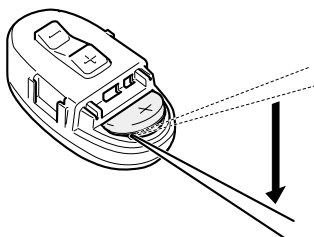

Precaution:

- Replace the battery with a CR2032 lithium battery.
- Replace the battery in the unit using a non metallic tapered instrument.

⚠ WARNING:

- Keep the lithium battery out of the reach of children. Should the battery be swallowed, immediately consult a doctor.

⚠ CAUTION:

- Do not recharge, disassemble, heat or dispose of the battery in a fire.
- Use a CR2032 (3 V) lithium battery only. Never use other types of battery with this unit.
- Do not handle the battery with metallic tools.
- Do not store the lithium battery with metallic materials.
- When disposing of used batteries, please comply with governmental regulations or environmental public institution's rules that apply in your country/area.
- Always check carefully that you are loading the battery with its (+) and (-) poles facing in the proper directions.

Using the steering remote controller

Precaution:

- Do not operate this unit while manipulating the steering wheel as this might result in a traffic accident.
- If you have to operate this unit unavoidably when driving, pay careful attention to the road ahead to avoid the risk of being involved in a traffic accident.
- If any of the following problems occur, immediately stop using this unit and consult with the dealer from whom you purchased it:
 - the unit is smoking.
 - the unit is emitting an abnormal odor.
 - a foreign object has entered the unit.
 - liquid has been spilled on or into the unit.If you continue to use this unit without rectifying the problem, the unit may be damaged badly, resulting in a serious accident or fire.
- Do not leave this unit free (unattached) inside the car. When the car stops or turns a curve, the unit might drop on the floor. If the unit rolls under the brake pedal, it might prevent the driver from braking properly, causing serious trouble. Be sure to fix this unit to the steering wheel.
- Do not disassemble or modify this unit. To do so may cause a malfunction.
- When VOLUME extends outward, the remote control may not work properly.

FUNCTION button and AUDIO button

Operation of the FUNCTION button and the AUDIO button on the remote controller differs from the operation of the FUNC button and the AUDIO button on the head unit. When operating the head unit, use the FUNC button and the AUDIO button to select the appropriate menu, then use the multi-function buttons to select the mode. When operating the remote controller, however, switch through the modes as described below to select the mode.

FUNCTION button operation

- Press **FUNCTION** to select the desired mode (e.g., built-in CD player).

Press FUNCTION repeatedly to switch between the following modes:

RPT → RDM → SCAN → T.LIST → PAUSE
→ TTLin

Note:

- Refer to “Built-in CD player function menu” on page 20.

AUDIO button operation

- Press **AUDIO** to select the desired mode.

Press AUDIO repeatedly to switch between the following modes:

F/B → LOUD → SFC → EQ1 → EQ2
→ ASL → POSI → T.AL1 → T.AL2 → SW1
→ SW2 → HPF F → HPF R → SLA
→ A.EQ → D.ATT

Note:

- Refer to “Audio menu” on page 56.

Displaying and setting the clock

You can turn the time display on or off and set the time.

Setting the time display on or off

1. **Press NEXT to display “CLK”.**
Press NEXT until “CLK” appears.
2. **Press CLK and then press ON/OFF to turn the time display on.**
The light illuminates. When the time display is turned on, “TIME”, “DATE” and “JUST” appear simultaneously.
 - Press ON/OFF again to turn the time display off.
 - If you press BAND and exit the calendar and time mode, the time display will appear instead of the source name.



Time display

Note:

- If you do not operate the function within about 60 seconds, the display is automatically returned.

Off clock display

When the time display is turned on, the calendar display appears with the time display when sources and the feature demo are off.

Setting the date

The calendar display adjusted in this mode appears only when sources and the feature demo are off.

1. **Press NEXT to display “CLK”.**
Press NEXT until “CLK” appears.
2. **Press CLK and then press DATE to set the date.**
3. **Press ◀ or ▶ to switch between day, month and year.**
4. **Press ▲ or ▼ to correct the date.**
Pressing ▲ advances the day, month or year.
Pressing ▼ turns back the day, month or year.

Setting the time

1. **Press NEXT to display “CLK”.**
Press NEXT until “CLK” appears.
2. **Press CLK and then press TIME to set the time.**
3. **Press ◀ or ▶ to switch between hour and minute.**
4. **Press ▲ or ▼ to adjust the time.**
Pressing ▲ advances the hour or minute.
Pressing ▼ turns back the hour or minute.

Matching the time to a time signal

1. **Press NEXT to display “CLK”.**
Press NEXT until “CLK” appears.
2. **Press CLK and then press JUST to match the time to a time signal.**
 - If the minute is “00” – “29”, the minutes are rounded down. (e.g., “10:18” becomes “10:00”.)
 - If the minute is “30” – “59”, the minutes are rounded up. (e.g., “10:36” becomes “11:00”.)

Note:

- During date adjustment, “JUST” is not displayed.

Detaching and replacing the front panel

WARNING:

- Do not use with the front panel left open. If the front panel is left open, it may result in injury in the event of an accident.
- Do not drive with the front panel removed. If the front panel is left removed, it may result in injury in the event of an accident.

Theft protection

The front panel of the head unit is detachable to discourage theft.

Precaution:

- Never use force or grip the display tightly when removing or replacing the front panel.
- Avoid subjecting the front panel to excessive shocks.
- Keep the front panel out of direct sunlight and high temperatures.

Detaching the front panel

1. Press **OPEN** to open the front panel.

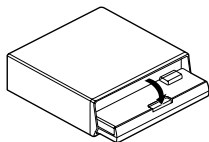

2. Slide the front panel toward you and remove it.

Take care not to grip the front panel tightly or drop it.

- Never remove the front panel while the access lamp is lit, as otherwise data may be destroyed. (See page 39.)

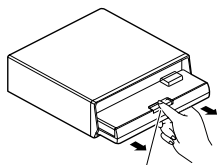

Release section

3. Close the inner cover.
4. Use the protective case provided to store/carry the detached front panel.

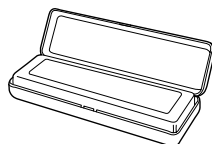

Replacing the front panel

1. Make sure the inner cover is closed.
2. Replace the front panel by clipping it into place.

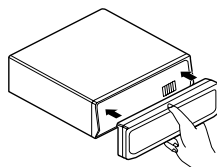

Warning tone

If the front panel is not detached within five seconds after the ignition is turned off, the warning tone will sound to remind you to detach the front panel.

Note:

- You can cancel the warning tone function. (Refer to page 66.)

Turning a source on or off

You can select the source you want to listen to. To switch to built-in CD player, load a CD in this product. (See page 19.) To switch to a "Memory Stick" player, load a "Memory Stick" in this product. (See page 39.)

1. Press SOURCE to select the desired source (e.g., tuner).

Press SOURCE repeatedly to switch between the following sources:
 Built-in CD player (MP3) → TV tuner
 → Tuner → DAB tuner → Music server
 → "Memory Stick" player → Multi-CD player
 → External unit 1 → External unit 2
 → AUX



2. Press VOLUME to extend the VOLUME outward.

- When you press VOLUME, it extends outward so that it becomes easier to turn. To retract VOLUME, press it again.

3. Turn VOLUME to adjust the volume.



4. Press and hold SOURCE to turn the source off.

Note:

- External unit refers to a Pioneer product (such as one available in the future) that, although incompatible as a source, enables control of basic functions by this product. Two external units can be controlled by this product, although "External" is displayed whether you select external unit 1 or external unit 2. When two external units are connected, the allocation of them to external unit 1 or external unit 2 is automatically set by this product.

- In the following cases, the sound source will not change:
 - * When no product corresponding to the source is connected to this product.
 - * No disc is set in this product.
 - * No "Memory Stick" is set in this product.
 - * No magazine is set in the multi-CD player.
 - * AUX (auxiliary setting) is set to off. (Refer to page 64.)
- When this product's blue/white lead is connected to the car's auto-antenna relay control terminal, the car's auto-antenna extends when this product's source is switched on. To retract the antenna, switch the source off.

SOFT KEY operation

SOFT KEY operation means that the function of a button changes as indicated on the display. The multi-function buttons provide SOFT KEY operation; the functions performed by the buttons change according to the function or setting that has been selected.

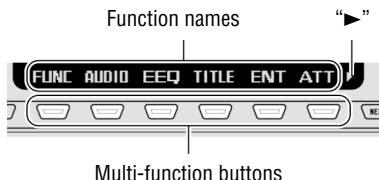

The explanations given in this manual are based on FORM 1 display. If you have selected FORM 2, the functions of some of the multi-function buttons may be different from those indicated in the manual.

Important

In this manual, for operations using the multi-function buttons the function displayed is used as the name of the function button.

Switching the function of the multi-function buttons

The “▶” indicator shows that the multi-function buttons have functions other than those currently displayed. When this indicator is visible, press NEXT to switch through the functions of the multi-function buttons.

- Press NEXT to display the desired functions (e.g., built-in CD player).

Press NEXT repeatedly to switch between the following functions:

FUNC AUDIO EEQ TITLE ENT ATT ▶



PAUSE CLK L.MENU ▶

Note:

- The number of functions or displays switched through will differ according to the source or menu selected.
- When no function is indicated for a button, that button is not currently active.

Example of multi-function button operation

Here the “random play” function of the built-in CD player is used as an example to illustrate operation of the multi-function buttons.

1. Press NEXT to display “FUNC”.

Press NEXT repeatedly until “FUNC” appears.

FUNC AUDIO EEQ TITLE ENT ATT ▶

2. Press FUNC to enter the function menu.

With the switch to the function menu, the functions of the multi-function buttons also change simultaneously.

RPT RDM SCAN T.LIST PAUSE ▶

3. Press RDM to select the random mode.



4. Press RDM to turn random play on.



The light illuminates.

- Press RDM again to turn random play off. The light goes off.

5. Press BACK to exit the function menu.

When the function menu is exited, the functions of the multi-function buttons also change simultaneously.

Note:

- You can also turn random play on or off by pressing ▲ or ▼ in the random mode.
- If you do not operate the function within about 30 seconds, the display is automatically returned.

The difference between the BAND button and the BACK button

BAND button

Pressing the BAND button immediately cancels the current menu or mode, and returns to the basic displays.

Note:

- When the source is the Tuner, TV tuner or DAB tuner and no menu or mode is selected, pressing the BAND button has the effect of switching bands.

BACK button

Pressing the BACK button cancels the current menu or mode and returns to the previously selected menu or mode.

Display example (e.g., built-in CD player)

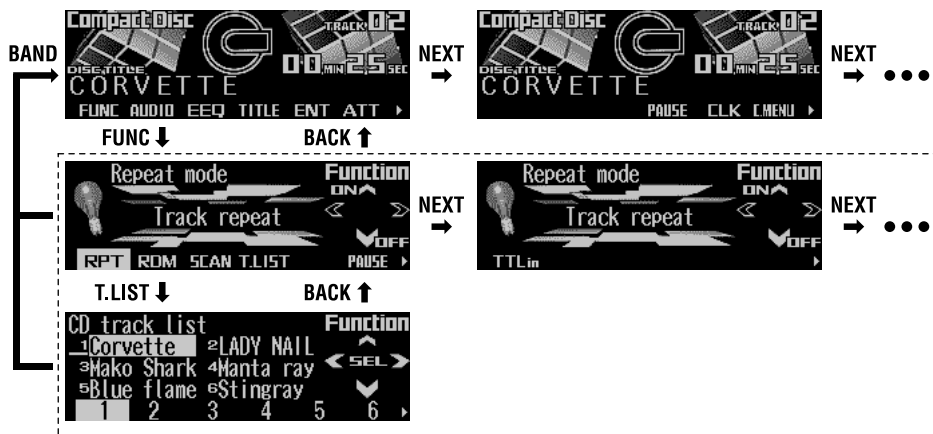

Key guidance indicator

This product's display features key guidance indicators. These light to indicate which of the $\blacktriangle/\blacktriangledown/\blacktriangleleft/\blacktriangleright$ buttons you can use. When you're in the function menu, audio menu or the other menus, they also make it easy to see which $\blacktriangle/\blacktriangledown/\blacktriangleleft/\blacktriangleright$ buttons you can use to switch functions on/off, switch repeat selections and perform other operations.



Key guidance indicators

Note:

- In this manual, operation for each mode is given mainly in terms of the multi-function buttons. However, in each mode, when the key guidance indicators are lit it is also possible to use $\blacktriangle/\blacktriangledown/\blacktriangleleft/\blacktriangleright$ to operate the mode.

Display and indicators

FORM 1

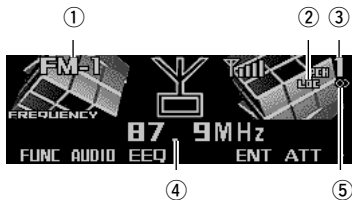

FORM 2

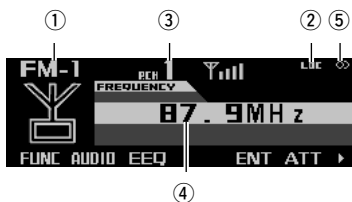

- ① Band
- ② LOC indicator
- ③ Preset number
- ④ Frequency
- ⑤ Stereo indicator

Basic operation

1. **Press SOURCE to select the tuner.**
Press SOURCE until "Tuner" appears.
2. **Press VOLUME to extend the VOLUME outward.**
 - When you press VOLUME, it extends outward so that it becomes easier to turn. To retract VOLUME, press it again.
3. **Turn VOLUME to adjust the volume.**

4. **Press BAND to select the desired band.**

Press BAND repeatedly to switch between the following bands:

FM-1 → FM-2 → FM-3 → AM

5. **Press ◀ or ▶ to tune in to a station.**

The frequencies move up or down step by step.

- If you press and hold ◀ or ▶ for about one second and release, you can perform seek tuning. Seek tuning lets you skip broadcasting stations until a broadcast strong enough for good reception is found.
- If you press and hold ◀ or ▶, you can skip broadcasting stations. Seek tuning starts as soon as you release the button.

Note:

- The stereo indicator "Ⓢ" lights when a stereo station is selected.

Storing and recalling broadcast stations

If you press any of the buttons 1 – 6, you can easily store up to six broadcast stations for later recall.

Storing broadcast stations

1. **Press NEXT to display "1" – "6".**
Press NEXT until "1" – "6" appears.
2. **When you find a station that you want to store in memory, press and hold any of the buttons 1 – 6 until the preset number stops flashing.**
The station is stored in memory under the selected button.

Note:

- Up to 18 FM stations, six for each of the three FM bands, and six AM stations can be stored in memory.

Recalling broadcast stations

1. Press **NEXT** to display “1” – “6”.
Press **NEXT** until “1” – “6” appears.
2. Press any of the buttons 1 – 6 to recall a station preset under that button.

Note:

- You can also use ▲ or ▼ to recall broadcast stations memorized in the buttons 1 – 6.

Tuner function menu

The tuner function menu has the following functions:

BSM chLIST LOC

Note:

- If you do not operate the function within about 30 seconds, the display is automatically returned.

Storing the strongest broadcast stations

BSM (best stations memory) lets you automatically store the six strongest broadcast stations under the buttons 1 – 6.

1. Press **FUNC** to select the **BSM** mode.
2. Press **BSM** to turn the **BSM** on.

“Searching” appears. The six strongest broadcast stations will be stored under the buttons 1 – 6 and in order of their signal strength.

When finished, “Searching” disappears and the display switches to the preset channel list mode.

- To cancel the storage process before it is completed, press **BSM** again while “Searching” appears.
3. Press any of the buttons 1 – 6 to recall the desired station.

FM1 P.CH List		Function	
1	87.9MHz	2	89.9MHz
3	98.1MHz	4	106.1MHz
5	107.9MHz	6	94.1MHz
1	2	3	4
5	6	SEL	6

Selecting stations from the preset channel list

The preset channel list lets you see the list of preset stations and select one of them to receive.

1. Press **FUNC** and then press **chLIST** to select the preset channel list mode.
2. Press any of the buttons 1 – 6 to recall the desired station.

FM1 P.CH List		Function	
1	87.9MHz	2	89.9MHz
3	98.1MHz	4	106.1MHz
5	107.9MHz	6	94.1MHz
1	2	3	4
5	6	SEL	6

Note:

- You can also use ◀, ▶ and ▲ to select and recall the desired station.

Tuning in strong signals

Local seek tuning lets you tune in only those broadcast stations with sufficiently strong signals for good reception.

1. Press **FUNC** and then press **LOC** to select the local mode.
2. Press **LOC** to set the local seek sensitivity.

Press **LOC** repeatedly to switch between the following settings:

FM: Local OFF → Level 1 → Level 2
→ Level 3 → Level 4

AM: Local OFF → Level 1 → Level 2

- When the local mode is exited except for “Local OFF” is selected, “LOC” appears on the basic display.

Note:

- The “Level 4” setting allows reception of only the strongest stations, while lower settings let you receive progressively weaker stations.

Display and indicators

FORM 1



FORM 2

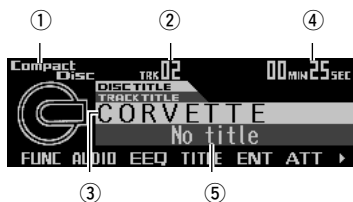

- ① Source name
- ② Track number
- ③ Disc title
- ④ Play time
- ⑤ Track title

Basic operation

The built-in CD player plays one standard 12 cm or 8 cm (single) CD at a time. Do not use an adapter when playing an 8 cm CD.

1. Press **OPEN** to open the front panel.
2. Insert a CD into the CD loading slot.

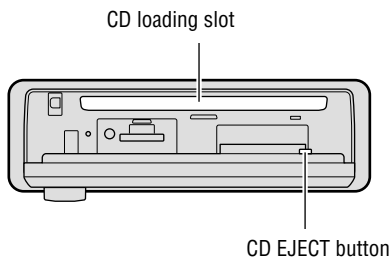

3. Close the front panel.

4. Press **VOLUME** to extend the **VOLUME** outward.

- When you press **VOLUME**, it extends outward so that it becomes easier to turn. To retract **VOLUME**, press it again.

5. Turn **VOLUME** to adjust the volume.

6. Press **◀** or **▶** to select a track.

Pressing **▶** skips to the start of the next track.

Pressing **◀** once skips to the start of the current track. Pressing again will skip to the previous track.

- If you press and hold **◀** or **▶**, you can perform fast forward or reverse.

7. Press **OPEN** and then press **CD EJECT** to eject the CD.

- Be sure to close the front panel after removing the CD.

WARNING:

- Do not use with the front panel left open. If the front panel is left open, it may result in injury in the event of an accident.

Note:

- You can select CD as the source by pressing **SOURCE** when a disc is loaded in this product.
- When the front panel is open, multi-function buttons are not available.
- Do not insert anything other than a CD into the CD loading slot.
- A CD left partially inserted after ejection may incur damage or fall out.
- If a CD cannot be inserted fully or playback fails, make sure the recorded side is down. Press the **CD EJECT** and check the disc for damage before reinserting it.
- If the built-in CD player cannot operate properly, an error message (such as "ERROR-12") appears on the display. Refer to "Understanding built-in CD player error messages" on page 74.

Switching and scrolling the title

When playing a CD TEXT disc, you can switch text display such as artist name and track title. With text longer than 32 letters, you can scroll to see the rest of the text.

1. Press **TITLE** to switch the title mode.
2. Press the corresponding button to display the desired title.

FORM 1

Button	Operation
D.TTL	Displays disc title.
D.ART	Displays disc artist name.
T.TTL	Displays track title.
T.ART	Displays track artist name.
THNDR	Displays thunderbolt animation.
SCROLL	Scrolls the displayed title.

FORM 2

Button	Operation
TTL1	Displays disc title and track title.
TTL2	Displays disc title and disc artist name.
TTL3	Displays track title and track artist name.
SCROLL	Scrolls the displayed title.

Note:

- If you do not operate the function within about eight seconds, the display is automatically returned.
- You cannot use ◀ or ▶ to select a track in title mode.
- When you select the display form 2, the titles are displayed up to 24 letters long.
- A CD TEXT disc is a CD featuring recorded text information such as disc title, artist name and track title.
- If certain text information is not recorded on a CD TEXT disc, “No ~” (e.g., “No title”) is displayed.
- If you have not input disc titles, “No title” is displayed.

Built-in CD player function menu

The built-in CD player function menu has the following functions:

RPT RDM SCAN T.LIST PAUSE ▶

TTLin ▶

Note:

- If you do not operate the function within about 30 seconds, the display is automatically returned. (When you select the disc title input mode (TTLin), the display is not returned automatically.)
- “T.LIST” is displayed only when playing a CD TEXT disc.

Repeating play

Repeat play lets you hear the same track over again.

1. Press **FUNC** to select the repeat mode.
2. Press **RPT** to turn the repeat play on.

The light illuminates. The track currently playing will play and then repeat.

- Press RPT again to turn repeat play off.
- When the repeat mode is exited while repeat play is on, “T.RPT” appears on the basic display.

Note:

- If you perform track search or fast forward/reverse, repeat play is automatically canceled.

Playing tracks in random order

Random play lets you play back tracks on the CD in random order.

1. Press **FUNC** and then press **RDM** to select the random mode.

2. Press **RDM** to turn random play on.

The light illuminates. Tracks will play in random order.

- Press **RDM** again to turn random play off.
- When the random mode is exited while random play is on, "RDM" appears on the basic display.

Scanning tracks of a CD

Scan play lets you hear the first 10 seconds of each track on the CD.

1. Press **FUNC** and then press **SCAN** to select the scan mode.

2. Press **SCAN** to turn scan play on.

The light illuminates. The first 10 seconds of each track are played.

- When the scan mode is exited while scan play is on, "SCAN" appears on the basic display.

3. When you find the desired track, press **SCAN** to turn scan play off.

The light goes off. The track will continue to play.

- If the scan mode is automatically canceled, select the scan mode again.

Note:

- After scanning of a CD is finished, normal playback of the tracks will begin again.

Selecting tracks from the track title list

The track title list lets you see the list of track titles on a CD TEXT disc and select one of them for playback.

1. Press **FUNC** and then press **T.LIST** to select the track title list mode.

2. Press **NEXT** to display the desired track title.

Press **NEXT** until the desired track title appears.



3. Press the corresponding number button to select the desired track title.

That selection will begin to play.

Note:

- You can also use ◀, ▶ and ▲ to select and play the desired track title.
- Only when playing a CD TEXT disc, you can switch to this mode.

Pausing CD playback

Pause lets you temporarily stop playback of the CD.

1. Press **FUNC** and then press **PAUSE** to select the pause mode.
2. Press **PAUSE** to turn the pause on.

The light illuminates. Play of the current track pauses.

- Press **PAUSE** again to turn the pause off.
- When the pause mode is exited while pause is on, "PAUSE" is displayed in the basic display.

Note:

- You can also turn pause on or off by pressing **PAUSE** in the following display.



PAUSE CLK E.MENU ▶

Entering disc titles

Disc title input lets you input up to 48 CD titles up to 10 letters long into the built-in CD player. If you input a CD title, the entered title is displayed.

For details of operation, refer to "Entering disc titles" on page 46 under "Multi-CD Player".

Note:

- When playing a CD TEXT disc, if you switch to this mode, "No title input" is displayed and you cannot input the title.
- After the titles for 48 discs have been entered, the data for a new disc will overwrite the oldest one.
- If you connect a multi-CD player, you can input disc titles for up to 100 discs.
- When a multi-CD player that does not support disc title functions is connected, you cannot enter disc titles in this product.

Display and indicators

FORM 1



FORM 2

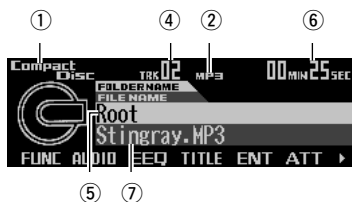

- ① Source name
- ② MP3 indicator
- ③ Bit rate indicator
- ④ Track number
- ⑤ Folder name
- ⑥ Play time
- ⑦ File name

Basic operation

The built-in CD player can playback MP3 files recorded on CD-ROM discs. (See page 71.)

1. Press **OPEN** to open the front panel.
2. Insert a CD-ROM into the CD loading slot.

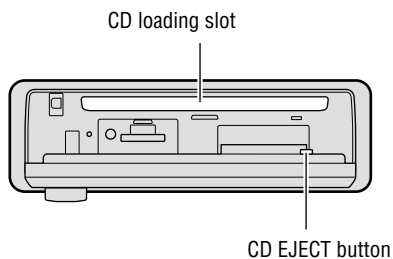

3. Close the front panel.

4. Press **VOLUME** to extend the **VOLUME** outward.
 - When you press **VOLUME**, it extends outward so that it becomes easier to turn. To retract **VOLUME**, press it again.
5. Turn **VOLUME** to adjust the volume.
6. Press **▲** or **▼** to select a folder.
 - You can not select a folder in which no MP3 file is recorded.
7. Press **◀** or **▶** to select a track.

Pressing **▶** skips to the start of the next track.

Pressing **◀** once skips to the start of the current track. Pressing again will skip to the previous track.

 - If you press and hold **◀** or **▶**, you can perform fast forward or reverse.
8. Press **OPEN** and then press **CD EJECT** to eject the CD-ROM.
 - Be sure to close the front panel after removing the CD-ROM.

! WARNING:

- Do not use with the front panel left open. If the front panel is left open, it may result in injury in the event of an accident.

Note:

- You can select MP3 as the source by pressing **SOURCE** when a CD-ROM is loaded in this product.
- When the front panel is open, multi-function buttons are not available.
- Do not insert anything other than a CD into the CD loading slot.
- A CD left partially inserted after ejection may incur damage or fall out.
- If a CD-ROM cannot be inserted fully or playback fails, make sure the recorded side is down. Press the **CD EJECT** and check the disc for damage before reinserting it.
- If the built-in CD player cannot operate properly, an error message (such as "ERROR-12") appears on the display. Refer to "Understanding built-in CD player error messages" on page 74.

Switching and scrolling the title

You can switch text display such as artist name and track title. With text longer than 32 letters, you can scroll to see the rest of the text.

1. Press **TITLE** to switch the title mode.
2. Press the corresponding button to display the desired title.

FORM 1

Button	Operation
FOLDER	Displays folder name.
FILE	Displays file name.
D.TTL	Displays disc title.
T.TTL	Displays track title.
ARTIST	Displays track artist name.
SCROLL	Scrolls the displayed title.

FORM 2

Button	Operation
F+FIL	Displays folder name and file name
FIL+T	Displays file name and track title.
D+TRK	Displays disc title and track title.
TR+ART	Displays track title and track artist name.
SCROLL	Scrolls the displayed title.

Note:

- If you do not operate the function within about eight seconds, the display is automatically returned.
- You cannot use ◀ or ▶ to select a track in title mode.
- When you select the display form 2, the titles are displayed up to 24 letters long.
- This product conforms to ISO9660 level 1 and level 2 standards. Correspondence to extended format is made with the following conditions.
Joliet: Correspondence only to the 8.3 format.
Romeo: Correspondence to folder names with up to 64 characters and file names with up to 63 characters (including the extension).

(See page 79.)

- Only the titles entered with the ID3 tag will be displayed for the disc title, the track title, and the artist name.
- If certain text information is not recorded on a MP3 file, "No ~" (e.g., "No title") is displayed.

MP3 function menu

The MP3 function menu has the following functions:

RPT ROM SCAN TLIST PAUSE ▶

TTLin ▶

Note:

- If you do not operate the function within about 30 seconds, the display is automatically returned. (When you select the disc title input mode (TTLin), the display is not returned automatically.)
- When playing a CD-ROM disc, if you switch to the disc title input mode (TTLin), "No title input" is displayed and you cannot input the title.

Repeating play

When playing back MP3 files, there are three repeat play ranges: one-track repeat, folder repeat and disc repeat.

1. Press **FUNC** to select the repeat mode.
2. Press **RPT** to select the repeat range.

Press RPT repeatedly to switch between the following repeat ranges:

- Track repeat (one-track repeat)
- Folder repeat (folder repeat)
- Disc repeat (disc repeat)

- When the repeat mode is exited, either "T.RPT" or "FOLDERRPT" may appear on the basic display.
 - "T.RPT" appears while the one-track repeat is selected.
 - "FOLDERRPT" appears while the folder repeat is selected.

Continued overleaf.

Note:

- If you select other folders during repeat play, the repeat range changes to disc repeat.
- If you perform track search or fast forward/reverse during one-track repeat, the repeat range changes to folder repeat.
- Folder repeat plays back the tracks (MP3 files) in the current folder only. Tracks in sub-folders are not played back.

Playing tracks in random order

Random play lets you play back tracks in the current folder in random order.

1. Press FUNC and then press RDM to select the random mode.**2. Press RDM to turn random play on.**

The light illuminates. Tracks will play in random order.

- Press RDM again to turn random play off.
- When the random mode is exited while random play is on, "RDM" appears on the basic display.

Note:

- Random play plays back the tracks (MP3 files) in the current folder only. Tracks in sub-folders are not played back.
- When you select disc repeat, when random play of all tracks in the current folder has been completed, random play will continue on the next folder.

Scanning folders and tracks

When you select folder repeat, scan play lets you hear the first 10 seconds of each track in the selected folder. When you select disc repeat, scan play lets you hear the first 10 seconds of the first track on each folder.

1. Select the repeat range.

Refer to "Repeating play" on page 24.

2. Press FUNC and then press SCAN to select the scan mode.**3. Press SCAN to turn scan play on.**

The light illuminates. The first 10 seconds of each track of the current folder (or the first track of each folder) are played.

- When the scan mode is exited while scan play is on, "SCAN" appears on the basic display.

4. When you find the desired track (or folder), press SCAN to turn scan play off.

The light goes off. The track (or folder) will continue to play.

- If the scan mode is automatically canceled, select the scan mode again.

Note:

- After track or folder scanning is finished, normal playback of the tracks will begin again.
- If you turn scan play on during one-track repeat, the repeat range changes to folder repeat.

Selecting tracks from the track title list

The track title list lets you see the list of track (or folder) titles on a CD-ROM disc and select one of them for playback.

1. Press **FUNC** and then press **T.LIST** to select the track title list mode.
2. Press **NEXT** to display the desired track (or folder) title.

Press **NEXT** until the desired track (or folder) title appears.

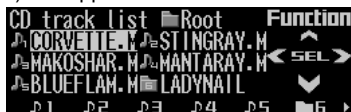

3. Press the corresponding number button to select the desired track (or folder) title.

That selection will begin to play.

- When you have selected a folder, a list of the titles of the tracks (or folder) in it can be viewed. Repeat steps 2 and 3 to select the desired track title.

Note:

- You can also use **◀**, **▶** and **▲** to select and play the desired track title.
- By pressing **▼**, you can return to the previous list (the folder one level higher).
- The track title is displayed as the file name of the MP3 file. (It is not displayed as the track title in the ID3 tag.)
- At the time of playback of an MP3 file, the track title list always is displayed from "ROOT".
- Folders containing only MP3 files which can not be played and folders containing no MP3 files also are displayed in the list.

Pausing MP3 playback

Pause lets you temporarily stop playback of the MP3.

1. Press **FUNC** and then press **PAUSE** to select the pause mode.
2. Press **PAUSE** to turn the pause on.

The light illuminates. Play of the current track pauses.

- Press **PAUSE** again to turn the pause off.
- When the pause mode is exited while pause is on, "PAUSE" is displayed in the basic display.

Note:

- You can also turn pause on or off by pressing **PAUSE** in the following display.



Display and indicators

During record standby

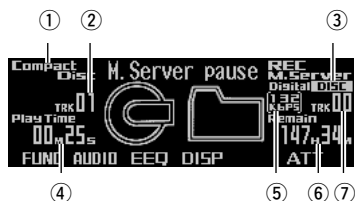

During recording

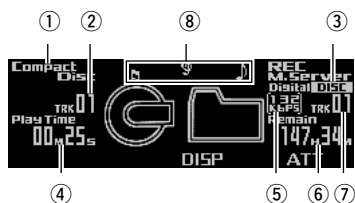

- ① Recording source name
- ② CD track number
- ③ Recording range indicator
- ④ CD information
- ⑤ Recording bit rate indicator
- ⑥ Remaining recordable time
- ⑦ Music server track number
- ⑧ Recording display

Note:

- The remaining recordable time is calculated based on the bit rate currently selected.

Before recording

- Even when the remaining recordable time of the music server is displayed as "00H00M", recording is possible until "M. Server full" is displayed.
- If the time remaining is shorter than the total time of CD or tracks to be recorded, "Time short" is displayed, allowing recording for only remaining time of the music server.
- Recordings are in stereo; mono recordings are not possible.
- When recording CD TEXT discs, the character information stored on the CD TEXT disc can not be recorded on the music server.
- You may erase recordings. (See page 37.)

- Recording standby is cancelled in the following cases:
 - * When the power is switched off.
 - * On ignition of the car engine.
 - * When the recording source is changed.
 - * When BAND is pressed.
 - * When a CD is inserted into the built-in CD player during recording from other device.
 - * When a record source device is disconnected (such as during Multi-CD recording.)
- Recording is cancelled in the following cases:
 - * On ignition of the car engine.
 - * When REC is pressed.
 - * When a record source device is disconnected (such as during Multi-CD recording.)
 - * When there is an error message from the music server or built-in CD player. (See pages 74 to 76.)
 - * When a skip has been repeated 3 times at the same position during recording from the built-in CD player.
- Track skip function is disabled during record standby or recording. Unnecessary tracks can be erased after recording.



PRECAUTION:

- Please may test recordings of recordings that can not be taken again.
- We cannot accept liability for data not recorded or lost due to the failure, improper operation or malfunction of this product.
- The use of recordings for purposes other than personal enjoyment, etc. are not permitted if they infringe copyrights and the rights of copyright claimants without prior consent.
- This product is not intended for recording from radio.

Digital and analog recording

This product is intended for digital recording from the built-in CD player to the music server. Recording from sources other than the built-in CD, such as multi-CD or AUX, will be recorded in analog. While digital recordings can be made with less loss of quality, we recommend recording from the built-in CD.

- It is not possible to digitally copy music to the music server if it was digitally recorded from CDs (such as CD-R).

This is set by SCMS, the Serial Copying Management System, which has been developed to prevent serial copies (copies of copies). (See page 80.)

- Analog recordings are stopped automatically after two hours. To continue recording to the same playlist file, press REC and restart the recording.

Bit rate

The bit rate can be selected for each recording. This alters the sound quality and recording time. (See page 30.)

Recording range

The range of recording from the built-in CD or multi-CD player is selectable. (See page 30.)

Recording from the built-in CD

Recording from CD-ROM is not possible. Not all recordings may be made from CD-R, CD-RW and other formats for reasons of copyright protection. (SCMS) (See page 80.)

1. Press **OPEN** to open the front panel.
2. Insert a CD into the CD loading slot.

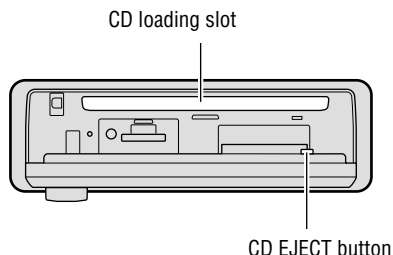

3. Close the front panel.

4. Press and hold **REC** until you have the **record standby status**.

"Ready" and "M.Server pause" appear in sequence and the product goes into the record standby status.

5. Press **FUNC** to select the **record mode setting mode**.

6. Press **R.MODE** to select the **recording range**.

Press R.MODE repeatedly to switch between the following ranges:

Disc (disc recording) → Track (one-track recording)

- Disc (disc recording) will record the disc you are listening to from the current track to the end of the disc. When disc recording has been interrupted, continued recording from the interrupted track is possible. (Refer to "Selecting the recording range" on page 30.)
- With Track (one-track recording), you can only record the track you are currently listening to.

7. Press **BAND** to cancel the **record mode setting mode**.

8. Press **◀** or **▶** to select the desired track.

9. Press **REC** to start the recording.

Recording starts automatically from the beginning of the track being listened to.

- When the recording ends, "M.Server pause" is displayed and the product goes into the record standby status.

10. Press **BAND** to cancel the **record standby status**.

Continued overleaf.

Note:

- If REC is pressed during recording, recording is terminated.
- In the event of skipping, the recording will revert to the beginning of the track (retry function).
- On record standby, the current track is repeated. This is cancelled when recording begins.
- Even if the random, track scan and pause are set to on, the current track is repeated when the mode is switched to the record standby status. When the recording is started, the repeat play is canceled.
- Fast forward and fast reverse do not operate when the product is on record standby.

Switching CD information

When recording from the built-in CD, you can switch CD information during record standby or recording.

- **Press DISP to change the CD information display.**

Press DISP repeatedly to switch between the following displays:

Recording range "Disc" and "Continue"

Play time → remaining disc time → total disc time

Recording range "Track"

Play time → remaining track time → total track time

Recording from a source other than the built-in CD

This product can make analog recordings from other equipment.

1. **Press SOURCE to select the desired source.**

Press SOURCE until the desired source appears.

2. **Press and hold REC until you have the record standby status.**

"Ready" and "M.Server pause" appear in sequence and the product goes into the record standby status.

- When performing multi-CD recording, you can set the recording mode (refer to "Selecting the recording range" on page 30) and the bit rate (refer to "Selecting the recording quality" on page 30).
- When recording from a source other than the multi-CD (such as a TV tuner or AUX output, etc.), the bit rate should be set only as specified (refer to "Selecting the recording quality" on page 30.)

3. **Press REC to start recording.**

Recording begins as soon as REC is pressed.

- When performing multi-CD recording, press ◀ or ▶ right before pressing REC to select the track.

4. **Press REC again to stop the recording.**

"Ready" and "M.Server pause" appear in sequence and the product goes into the record standby status.

5. **Press BAND to cancel the record standby status.**

Note:

- If the CD sound from the source CD falls below a certain level, a track number will be added automatically. By pressing ▲ during recording, it is possible to add a track number manually (up to 400).
- Depending on the recording source CD, the unit may determine a track ends in the middle or may not be able to determine the end of a track.
- If the CD skips during recording, it will be recorded as is.
- When recording where there is a lot of vibration, such as on the road, track numbers will be added automatically.

Recording function menu

The recording function menu has the following functions:

R.MODE RATE

Note:

- If you do not operate the function within about 30 seconds, the display is automatically returned.
- The record mode setting mode (R.MODE) is displayed for settings only for CD recording.

Selecting the recording range

It is possible to select the recording range when recording from a CD.

1. In record standby, press **FUNC** to select the recording mode setting mode.
2. Press **R.MODE** to select the recording range.

Press **R.MODE** repeatedly to switch between the following recording ranges:

Built-in CD recording

Disc (disc recording) → (Continue (continuous recording)) → Track (one-track recording)

- Disc (disc recording) will record the disc you are listening to from the current track to the end of the disc.
- Continue (continuous recording) continues recording from the interrupted disc recording to the last track of the CD. (Even when a track other than the interrupted one is selected, recording will be performed from the interrupted track.)
- With Track (one-track recording), you can only record the track you are currently listening to.

Note:

- When Disc (disc recording) has been interrupted, and record standby is performed again, Continue (continuous recording) will be performed, except in the following cases.
 - * In case of interruption because of an error.
 - * When the CD has been removed after the interruption.
 - * In case of recording with "Track" after the interruption.
 - * When the interruption has been caused by disconnecting the yellow lead (+ Battery) of this product.
- With Disc (disc recording), you cannot select and record only the track to be recorded. Unwanted tracks can be deleted from the music server after recording. (See page 37.)

Multi-CD Recording

All (all tracks recording) → Track (one-track recording)

- With Track (one-track recording), you can only record the track you are currently listening to (not from the beginning of the track).
- On All (all tracks recording) you can record all tracks from the one you are listening to until you stop recording. (No rewind to the beginning of track or disc.)

Selecting the recording quality

When recording it is possible to select the sound quality. The larger the recording bit rate number, the higher the sound quality, although the total recording time will be shorter.

1. In record standby, press **FUNC** and then press **RATE** to select the recording bit rate mode.
2. Press **RATE** to select the recording bit rate.

Press **RATE** repeatedly to switch between the following setting:
132 kbps → 105 kbps

Note:

- The bit rate allows digital and analog recordings to be recorded in separate settings. (There is no need to change the setting when you wish to keep the bit rate previously set.)

Display and indicators

FORM 1



FORM 2

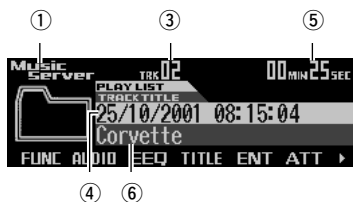

- ① Source name
- ② Bit rate indicator
- ③ Track number
- ④ Playlist file name
- ⑤ Play time
- ⑥ Track title

Basic operation

It is possible to play back tracks recorded on the music server.

1. Press SOURCE to select the music server.

Press SOURCE until "Music Server" appears.

2. Press VOLUME to extend the VOLUME outward.

- When you press VOLUME, it extends outward so that it becomes easier to turn. To retract VOLUME, press it again.

3. Turn VOLUME to adjust the volume.

4. Press ▲ or ▼ to select a playlist file.

5. Press ◀ or ▶ to select a track.

Pressing ▶ skips to the start of the next track.

Pressing ◀ once skips to the start of the current track. Pressing again will skip to the previous track.

- If you press and hold ◀ or ▶, you can perform fast forward or reverse.

Note:

- If no music is recorded on the music server, "No audio" is displayed.
- If the music server cannot operate properly, an error message such as "ERROR-30" is displayed. Refer to "Understanding music server error messages" on page 75.
- When ACC ON/OFF is performed during internal processing, "Processing" may be displayed. In this case, please wait until the display goes out.

Selecting the playlist mode

The playlist mode uses playlist files that group tracks according to the recording conditions at the time of recording. The mode allows you to play back only desired groups of tracks.

1. Press BAND to select the desired playlist mode.

Press BAND repeatedly to switch between the following modes:

All (each recording date) → Digital (digital recordings) → Analog (analog recordings) → Artist (artist) → Custom (custom)

Note:

- If you switch to playlist mode when nothing has been recorded, "No PlayList" or "No audio" is displayed.

Playlist files

Playlist files are lists of information on groups of tracks, containing such details as recording date, digital/analog and location. For every track, the playlist will contain the date of recording, whether it is digital, and the artist's name, etc. (Music data is stored only in the playlist file for each recording date.)

- Playlist files for each recording date store tracks and the information on each track respectively.
- In playlist files for digital recordings, the information for each track is stored separately. (When the recording range is "Disc" or "Continue", the entire list becomes one playlist file, and when the recording range is "Track", the range from the start of recording to the end becomes one playlist file.)
- In playlist files for analog recordings, the information for each track is stored separately.
- Artist playlist files store track information by artist, if there is an artist's name in the database when making digital recordings.
- Custom playlist files can be created containing favorite tracks.

Using the custom playlist mode

The custom playlist mode allows you to create playlist files to record and play back your favorite tracks. You can create six custom playlist files.

Recording tracks in a custom playlist file

1. Press **NEXT** to display "CSTM1" – "CSTM6".

Press **NEXT** until "CSTM1" – "CSTM6" appears.

CSTM1 CSTM2 CSTM3 CSTM4 CSTM5 CSTM6 ▶

2. When you find a track that you want to store in a custom playlist file, press and hold any of the buttons **CSTM1 – CSTM6** until "Finished recording" appears.

The track is stored in memory under the selected button.

- When a track has been selected from custom playlist files and the button shown reversed is pressed for two seconds or longer, the track being played will be deleted.

Note:

- You can record up to 99 tracks in a playlist file.
- The tracks are played back in the order in which they are stored.
- If an existing track is recorded again, it will be duplicated.

Selecting a custom playlist file directly

1. Press **NEXT** to display "CSTM1" – "CSTM6".

Press **NEXT** until "CSTM1" – "CSTM6" appears.

2. Press any of the buttons **CSTM1 – CSTM6** to select the desired custom playlist file.

Note:

- You can select the desired custom playlist file by pressing **▲** or **▼**.

Deleting a track from a custom playlist file

1. Press **NEXT** to display "CSTM1" – "CSTM6".

Press **NEXT** until "CSTM1" – "CSTM6" appears.

2. Press any of the buttons **CSTM1 – CSTM6** to select the custom playlist file from which you wish to delete a track.

3. Press **◀** or **▶** to select the desired track.

4. Press and hold the button with the same number of the selected custom playlist file until "Finished erasing" appears.

The track currently playing is erased from the custom playlist file.

Switching and scrolling the title

You can switch the text display to view such information as artist name and track title. With text longer than 32 letters, you can scroll to see the rest of the text.

- When recording from the built-in CD it is possible to take an artist name or track title, etc. from the built-in Gracenote CDDDB database. (It is not possible to retrieve a title if there is no information on the CD in the database.)

1. Press **TITLE** to switch the title mode.
2. Press the corresponding button to display the desired title.

FORM 1

Button	Operation
P.L TTT	Displays playlist file title.
T.TTT	Displays track title.
ARTIST	Displays track artist name.
SCROLL	Scrolls the displayed title.

FORM 2

Button	Operation
P.L+TTT	Displays playlist file title and track title.
TR+ART	Displays track title and track artist name.
SCROLL	Scrolls the displayed title.

Note:

- If you do not operate the function within about eight seconds, the display is automatically returned.
- You cannot use ▲/▼/◀/▶ to select a playlist file or track in title mode.
- When you select the display form 2, the titles are displayed up to 24 letters long.
- If you have not input track titles, "No title" is displayed.

Gracenote CDDDB

Gracenote is CDDDB, Inc. d/b/a "Gracenote." CD-related data from Gracenote CDDDB®, copyright 1999, 2000, 2001 Gracenote. Gracenote CDDDB Client Software, copyright 1999, 2000, 2001 CDDDB, Inc. U.S. Patents Numbers #5,987,525; #6,061,680; #6,154,773, and other patents issued or pending.

CDDDB is a registered trademark of Gracenote. The Gracenote logo and the Gracenote CDDDB logo are trademarks of Gracenote. Music Recognition Service and MRS are service marks of Gracenote.

Music recognition technology and meta-database are provided by Gracenote and the Gracenote CDDDB® Music Recognition Service. Gracenote is the industry standard in music recognition technology and related content delivery. For more information go to www.gracenote.com.



Note:

- Pioneer is not responsible for data provided by Gracenote and the Gracenote CDDDB service.

Music server function menu

The music server function menu has the following functions:



Note:

- If you do not operate the function within about 30 seconds, the display is automatically returned. (When you select title input modes (P.L.in, TRK.in, ART.in), the display is not returned automatically.)

Repeating play

There are three repeat play ranges for the music server: one-track repeat, playlist file repeat and playlist mode repeat.

1. Press FUNC to select the repeat mode.

2. Press RPT to select the repeat range.

Press RPT repeatedly to switch between the following repeat ranges:

Track repeat (one-track repeat)

→ PlayList repeat (playlist file repeat)

→ PlayList mode repeat (playlist mode repeat)

- When the repeat mode is exited, either "T.RPT" or "P.LISTRPT" may appear on the basic display.
 - "T.RPT" appears while the one-track repeat is selected.
 - "P.LISTRPT" appears while the playlist file repeat is selected.

Note:

- If you select other playlist files during repeat play, the repeat range changes to playlist mode repeat.
- If you perform track search or fast forward/reverse during one-track repeat, the repeat range changes to playlist file repeat.

Playing tracks in random order

Random play lets you play back tracks in the playlist file in random order.

1. Press FUNC and then press RDM to select the random mode.

2. Press RDM to turn random play on.

The light illuminates. Tracks will play in random order.

- Press RDM again to turn random play off.
- When the random mode is exited while random play is on, "RDM" appears on the basic display.

Note:

- When you select the playlist mode repeat, when the random play of all tracks in the current file has been completed, random play will continue on the next file.

Scanning files and tracks

When you select playlist file repeat, scan play lets you hear the first 10 seconds of each track in the selected playlist file. When you select playlist mode repeat, scan play lets you hear the first 10 seconds of the first track in each playlist file.

1. Select the repeat range.

Refer to "Repeating play" on this page.

2. Press FUNC and then press SCAN to select the scan mode.

3. Press SCAN to turn scan play on.

The light illuminates. The first 10 seconds of each track in the current playlist file (or the first track of each playlist file) are played.

- When the scan mode is exited while scan play is on, "SCAN" appears on the basic display.

Continued overleaf.

- When you find the desired track (or playlist file), press **SCAN** to turn scan play off.

The light goes off. The track (or playlist file) will continue to play.

- If the scan mode is automatically canceled, select the scan mode again.

Note:

- After track or playlist file scanning is finished, normal playback of the tracks will begin again.
- If you turn scan play on during one-track repeat, the repeat range changes to playlist file repeat.

Selecting tracks from the track title list

The track title list lets you see the list of track titles in a playlist file and select one of them for playback.

- Press **FUNC** and then press **T.LIST** to select the track title list mode.
- Press **NEXT** to display the desired track title.

Press **NEXT** until the desired track title appears.



- Press the corresponding number button to select the desired track title.

That selection will begin to play.

Note:

- You can also use **◀**, **▶** and **▲** to select and play the desired track title.
- If you have not input track titles, "No T.Title" is displayed.
- When the playlist file changes, the track title list mode will be cancelled automatically.

Selecting files from the playlist file title list

The playlist file title list lets you see the list of playlist file titles in a playlist mode and select one of them for playback.

- Press **FUNC** and then press **P.LIST** to select the playlist file title list mode.
- Press **NEXT** to display the desired playlist file title.

Press **NEXT** until the desired playlist file title appears.



- Press the corresponding number button to select the desired playlist file title.

That selection will begin to play.

Note:

- You can also use **◀**, **▶** and **▲** to select and play the desired playlist file title.
- If you have not input playlist file titles, "No title" is displayed.
- If nothing is recorded on the music server, "No audio" is displayed.

Pausing music server playback

Pause lets you temporarily stop playback of the music server.

- Press **FUNC** and then press **PAUSE** to select the pause mode.

2. Press PAUSE to turn pause on.

The light illuminates. Play of the current track pauses.

- Press PAUSE again to turn pause off.
- When the pause mode is exited while pause is on, "PAUSE" is displayed in the basic display.

Note:

- You can also turn pause on or off by pressing PAUSE in the following display.



Entering titles

The playlist file title, track title and track artist's name can each be up to 20 characters for entry into the music server.

- When the playlist file changes while entering a title, the title input mode will be cancelled automatically.
- If you retrieve a title of over 21 characters from the built-in database, this product will edit the entry and delete all characters beyond 21.
- If you edit a title from the built-in database, some characters on the title input display may become blank.

Entering playlist file titles

1. Press ▲ or ▼ to play a playlist file you want to enter the title.
2. Press FUNC and NEXT and then press P.L.in to select the playlist file title input mode.

Refer to "Entering disc titles" on page 46, and perform procedures 3 to 7 in the same way.

Entering track titles

1. Press FUNC and NEXT and then press TRKin to select the track title input mode.
2. Press ◀ or ▶ to play a track you want to enter the title.
3. Press ▲ to switch the track title input display.

Refer to "Entering disc titles" on page 46, and perform procedures 3 to 7 in the same way.

Note:

- When entering a track title, the track title will be given to the intended track, even in case of change to the next track.

Entering track artist names

1. Press FUNC and NEXT and then press ARTin to select the track artist name input mode.
2. Press ◀ or ▶ to play a track you want to enter the artist name.
3. Press ▲ to switch the artist name input display.

Refer to "Entering disc titles" on page 46, and perform procedures 3 to 7 in the same way.

Note:

- When entering an artist's name, the artist's name will be given to the intended track, even in case of change to the next track.
- The artist's name entered with this product will not be recorded in the artist playlist file.

Selecting the playlist mode

In playlist mode, a playlist file is used to distinguish a group of tracks that have been defined as a group when recorded. This mode allows you to play back the tracks you want to hear as a group. (See page 31.)

1. Press **FUNC** and **NEXT** and then press **P.MODE** to select the playlist mode selection mode.
2. Press **P.MODE** to select the desired playlist mode.

Press **P.MODE** repeatedly to switch between the following mode:

All (each recording date) → Digital (digital recordings) → Analog (analog recordings) → Artist (artist) → Custom (custom)

Note:

- If you switch to playlist mode when nothing has been recorded, “No Playlist” or “No audio” is displayed.

Deleting tracks and track information

In playlist mode it is possible to delete tracks and track information recorded in playlist mode. However, in “All” mode, the track data is deleted along with the track information. With the “All” mode, the confirmation screen will show other items than those selected, so always verify this when using this mode.

When selecting “All”

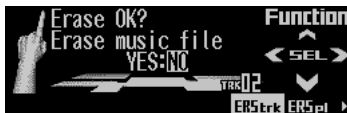

When selecting other than “All”



Erasing a track from playlist file

Precaution:

- Once a track is erased, it can not be restored. Always check the confirmation screen before erasing.

1. Press **▲** or **▼** to select the desired playlist file.
2. Press **FUNC** and then press **NEXT** twice.
3. Press **ERStrk** to select the one-track erase mode.
4. Press **◀** or **▶** to select the desired track.
5. Press **▲** to erase the currently playing track from the playlist file.



6. Press **◀** and then press **▲** to select “YES”.
 - To prevent erasure of the track, press **▶** and **▲** and select “NO”.

Note:

- When the playlist file changes, the one-track erase mode will be cancelled automatically.
- You can not adjust the volume while “YES” is selected and during erasing.

Erasing a playlist file from playlist mode

Precaution:

- Once a playlist file is erased, it can not be restored. Always check the confirmation screen before erasing.

- Press ▲ or ▼ to select the playlist file you want to erase from playlist mode.
- Press FUNC and then press NEXT twice.
- Press ERSpl to select the playlist file erase mode.
- Press ▲ to erase the selected playlist file from playlist mode.



- Press ◀ and then press ▲ to select "YES".
 - To prevent erasure of the playlist file, press ▶ and ▲ and select "NO".

Note:

- You can not adjust the volume while "YES" is selected and during erasing.

Display and indicators

FORM 1



FORM 2

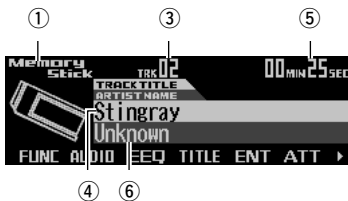

- ① Source name
- ② Bit rate indicator
- ③ Track number
- ④ Track title
- ⑤ Play time
- ⑥ Track artist name

Basic operation

The "Memory Stick" player plays one "MagicGate Memory Stick (MG Memory Stick)" at a time. (See page 72.)

1. Press **OPEN** to open the front panel.
2. Insert a "Memory Stick" into the MS loading slot until it clicks into position.

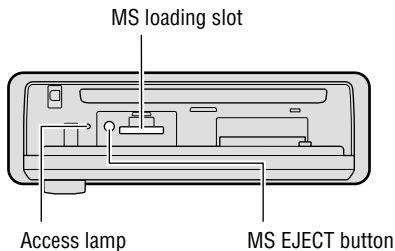

3. Close the front panel.

4. Press **VOLUME** to extend the **VOLUME** outward.
 - When you press **VOLUME**, it extends outward so that it becomes easier to turn. To retract **VOLUME**, press it again.
5. Turn **VOLUME** to adjust the volume.
6. Press **◀** or **▶** to select a track.
 - Pressing **▶** skips to the start of the next track.
 - Pressing **◀** once skips to the start of the current track. Pressing again will skip to the previous track.
 - If you press and hold **◀** or **▶**, you can perform fast forward or reverse.
7. Press **OPEN** and then press **MS EJECT** to eject the "Memory Stick".
 - The access lamp lights while data are being written. Never remove the "Memory Stick" while the access lamp is lit, as otherwise data may be destroyed.
 - Be sure to close the front panel after removing the "Memory Stick".

! WARNING:

- Do not use with the front panel left open. If the front panel is left open, it may result in injury in the event of an accident.

Note:

- You can select "Memory Stick" as the source by pressing **SOURCE** when a "Memory Stick" is loaded in this product.
- When the front panel is open, multi-function buttons are not available.
- Do not insert anything other than a "Memory Stick" into the MS loading slot.
- A "Memory Stick" left partially inserted after ejection may incur damage or fall out.
- If the "Memory Stick" player cannot operate properly, an error message (such as "ERROR-30") appears on the display. Refer to "Understanding "Memory Stick" player error messages" on page 77.
- During playback of music data with a limited number of playbacks, fast forward and reverse are not possible, so that the number of playbacks can be managed correctly.
- When **TA** interruption occurs during playback of music data with a limited number of playbacks, the number of playbacks is decreased by one. This can be prevented by setting **TA** interruption to **OFF** in advance.

Switching and scrolling the title

You can switch text display such as artist name and track title.

With text longer than 32 letters, you can scroll to see the rest of the text.

1. Press **TITLE** to switch the title mode.
2. Press the corresponding button to display the desired title.

FORM 1

Button	Operation
T.TTL	Displays track title.
ARTIST	Displays track artist name.
THNDR	Displays thunderbolt animation.
SCROLL	Scrolls the displayed title.

FORM 2

Button	Operation
SCROLL	Scrolls the displayed title.

Note:

- If you do not operate the function within about eight seconds, the display is automatically returned.
- You cannot use ◀ or ▶ to select a track in title mode.
- When you select the display form 2, the titles are displayed up to 24 letters long.
- If certain text information is not recorded on a “Memory Stick”, “No ~” (e.g., “No title”) is displayed.

“Memory Stick” player function menu

The “Memory Stick” player function menu has the following functions:

RPT RDM SCAN T.LIST PAUSE ▶

ERS_{trk} ERS_{all} ▶

Note:

- If you do not operate the function within about 30 seconds, the display is automatically returned.

Repeating play

Repeat play lets you hear the same track over again.

1. Press **FUNC** to select the repeat mode.
2. Press **RPT** to turn the repeat play on.

The light illuminates. The track currently playing will play and then repeat.

- Press **RPT** again to turn repeat play off.
- When the repeat mode is exited while repeat play is on, “T.RPT” appears on the basic display.

Note:

- If you perform track search or fast forward/reverse, repeat play is automatically canceled.

Playing tracks in random order

Random play lets you play back tracks on the “Memory Stick” in random order.

1. Press **FUNC** and then press **RDM** to select the random mode.
2. Press **RDM** to turn random play on.

The light illuminates. Tracks will play in random order.

- Press **RDM** again to turn random play off.
- When the random mode is exited while random play is on, “RDM” appears on the basic display.

Scanning tracks of a “Memory Stick”

Scan play lets you hear the first 10 seconds of each track on the “Memory Stick”.

1. Press **FUNC** and then press **SCAN** to select the scan mode.
2. Press **SCAN** to turn scan play on.

The light illuminates. The first 10 seconds of each track are played.

- When the scan mode is exited while scan play is on, “SCAN” appears on the basic display.

3. When you find the desired track, press **SCAN** to turn scan play off.

The light goes off. The track will continue to play.

- If the scan mode is automatically canceled, select the scan mode again.

Note:

- After scanning of a “Memory Stick” is finished, normal playback of the tracks will begin again.

Selecting tracks from the track title list

The track title list lets you see the list of track titles on a “Memory Stick” and select one of them for playback.

1. Press **FUNC** and then press **T.LIST** to select the track title list mode.

2. Press **NEXT** to display the desired track title.

Press **NEXT** until the desired track title appears.



3. Press the corresponding number button to select the desired track title.

That selection will begin to play.

Note:

- You can also use ◀, ▶ and ▲ to select and play the desired track title.

Pausing “Memory Stick” playback

Pause lets you temporarily stop playback of the “Memory Stick”.

1. Press **FUNC** and then press **PAUSE** to select the pause mode.
2. Press **PAUSE** to turn the pause on.

The light illuminates. Play of the current track pauses.

- Press **PAUSE** again to turn the pause off.
- When the pause mode is exited while pause is on, “PAUSE” is displayed in the basic display.

Note:

- You can also turn pause on or off by pressing **PAUSE** in the following display.



Erasing tracks from the “Memory Stick”

Tracks may be erased from the “Memory Stick”, either one track at a time or all at once.

Erasing a track from the “Memory Stick”

1. Press **FUNC** and **NEXT** and then press **ERStrk** to select the one-track erase mode.
2. Press **◀** or **▶** to select the desired track.
3. Press **▲** to erase the currently playing track from the “Memory Stick”.

The confirmation screen appears.

4. Press **◀** and then press **▲** to select “YES”.
 - To prevent erasure of the track, press **▶** and **▲** and select “NO”.

Note:

- If you erase all tracks, the function menu will be cancelled and “No audio” is displayed.
- You can not adjust the volume while “YES” is selected and during erasing.

Erasing all tracks from the “Memory Stick”

1. Press **FUNC** and **NEXT** and then press **ERSall** to select the erase all tracks mode.
2. Press **▲** to erase all tracks from the “Memory Stick”.
The confirmation screen appears.
3. Press **◀** and then press **▲** to select “YES”.

When the tracks have been erased, the function menu is cancelled and “No audio” is displayed.

- To prevent erasure of all tracks, press **▶** and **▲** and select “NO”.

Note:

- You can not adjust the volume while “YES” is selected and during erasing.

Display and indicators

FORM 1



FORM 2



- ① Source name
- ② Disc number
- ③ Track number
- ④ Disc title
- ⑤ Play time
- ⑥ Track title

50-disc multi-CD player

Only those functions described in this manual are supported for 50-disc multi-CD players.

Basic operation

This product can control a multi-CD player, which is sold separately.

1. Press SOURCE to select the multi-CD player.

Press SOURCE until "Multi-CD" appears.

2. Press VOLUME to extend the VOLUME outward.

- When you press VOLUME, it extends outward so that it becomes easier to turn. To retract VOLUME, press it again.

3. Turn VOLUME to adjust the volume.

4. Press ▲ or ▼ to select a disc.

A disc number for which there is no disc will be skipped.

- You can use the buttons 1 – 6 (or 7 – 12) to select a disc directly.

5. Press ◀ or ▶ to select a track.

Pressing ▶ skips to the start of the next track.

Pressing ◀ once skips to the start of the current track. Pressing again will skip to the previous track.

- If you press and hold ◀ or ▶, you can perform fast forward or reverse.

Note:

- When the multi-CD player is performing the preparatory operations, "Ready" is displayed.
- If the multi-CD player cannot operate properly, an error message such as "ERROR-12" is displayed. Refer to the multi-CD player owner's manual.
- If there are no discs in the multi-CD player magazine, "No disc" is displayed.

Selecting a disc directly

You can use the buttons 1 – 6 (or 7 – 12) to select a disc directly.

1. Press NEXT to display "1" – "6" (or "7" – "12").

Press NEXT until "1" – "6" (or "7" – "12") appears.



2. Press any of the buttons 1 – 6 (or 7 – 12) to select a disc located at 1 to 6 (or 7 to 12).

Note:

- You cannot display "7" – "12" when a 6-disc multi-CD player is connected.

Switching and scrolling the title

When playing a CD TEXT disc on a CD TEXT compatible multi-CD player, you can switch text display such as artist name and track title.

With text longer than 32 letters, you can scroll to see the rest of the text.

1. Press **TITLE** to switch the title mode.
2. Press the corresponding button to display the desired title.

FORM 1

Button	Operation
D.TTL	Displays disc title.
D.ART	Displays disc artist name.
T.TTL	Displays track title.
T.ART	Displays track artist name.
THNDR	Displays thunderbolt animation.
SCROLL	Scrolls the displayed title.

FORM 2

Button	Operation
TTL1	Displays disc title and track title.
TTL2	Displays disc title and disc artist name.
TTL3	Displays track title and track artist name.
SCROLL	Scrolls the displayed title.

Note:

- If you do not operate the function within about eight seconds, the display is automatically returned.
- You cannot use ▲/▼/◀/▶ to select a disc or track in title mode.
- When you select the display form 2, the titles are displayed up to 24 letters long.
- A CD TEXT disc is a CD featuring recorded text information such as disc title, artist name and track title.
- If certain text information is not recorded on a CD TEXT disc, "No ~" (e.g., "No title") is displayed.
- If you have not input disc titles, "No title" is displayed.

Multi-CD player function menu

The multi-CD player function menu has the following functions:

RPT RDM SCAN T.LIST D.LIST PAUSE ▶

TTLin COMP ITS.P ITS.M ▶

Note:

- If you do not operate the function within about 30 seconds, the display is automatically returned. (When you select the disc title input mode (TTLin) or ITS memory mode (ITS.M), the display is not returned automatically.)
- "T.LIST" is displayed only when playing a CD TEXT disc on a CD TEXT compatible multi-CD player.

Repeating play

There are three repeat play ranges for the multi-CD player: one-track repeat, disc repeat and multi-CD player repeat.

1. Press **FUNC** to select the repeat mode.
2. Press **RPT** to select the repeat range.

Press RPT repeatedly to switch between the following repeat ranges:

Magazine repeat (multi-CD player repeat)

→ Track repeat (one-track repeat)

→ Disc repeat (disc repeat)

- When the repeat mode is exited, either "T.RPT" or "D.RPT" may appear on the basic display.
 - "T.RPT" appears while the one-track repeat is selected.
 - "D.RPT" appears while the disc repeat is selected.

Note:

- If you select other discs during repeat play, the repeat range changes to multi-CD player repeat.
- If you perform track search or fast forward/reverse during one-track repeat, the repeat range changes to disc repeat.

Playing tracks in random order

Random play lets you play back tracks in random order within the repeat range: multi-CD player repeat and disc repeat.

1. Select the repeat range.

Refer to "Repeating play" on page 44.

2. Press **FUNC** and then press **RDM** to select the random mode.

3. Press **RDM** to turn random play on.

The light illuminates. Tracks will play in random order within the selected repeat range.

- Press **RDM** again to turn random play off.
- When the random mode is exited while random play is on, "RDM" appears on the basic display.

Note:

- If you turn random play on during one-track repeat, the repeat range changes to disc repeat.

Scanning CDs and tracks

When you select disc repeat, scan play lets you hear the first 10 seconds of each track on the selected CD. When you select multi-CD player repeat, scan play lets you hear the first 10 seconds of the first track on each CD.

1. Select the repeat range.

Refer to "Repeating play" on page 44.

2. Press **FUNC** and then press **SCAN** to select the scan mode.

3. Press **SCAN** to turn scan play on.

The light illuminates. The first 10 seconds of each track of the current disc (or the first track of each disc) are played.

- When the scan mode is exited while scan play is on, "SCAN" appears on the basic display.

4. When you find the desired track (or disc), press **SCAN** to turn scan play off.

The light goes off. The track (or disc) will continue to play.

- If the scan mode is automatically canceled, select the scan mode again.

Note:

- After track or disc scanning is finished, normal playback of the tracks will begin again.
- If you turn scan play on during one-track repeat, the repeat range changes to disc repeat.

Selecting tracks from the track title list

The track title list lets you see the list of track titles on a CD TEXT disc and select one of them for playback.

1. Press **FUNC** and then press **T.LIST** to select the track title list mode.

2. Press **NEXT** to display the desired track title.

Press **NEXT** until the desired track title appears.



3. Press the corresponding number button to select the desired track title.

That selection will begin to play.

Note:

- You can also use **◀**, **▶** and **▲** to select and play the desired track title.
- Only when playing a CD TEXT disc on a CD TEXT compatible multi-CD player, you can switch to this mode.

Selecting discs from the disc title list

The disc title list lets you see the list of disc titles and select one of them for playback. Displayed disc titles are those which have been entered into the multi-CD player or recorded on a CD TEXT disc.

1. Press **FUNC** and then press **D.LIST** to select the disc title list mode.
2. Press **NEXT** to switch between “1” – “6” and “7” – “12”.

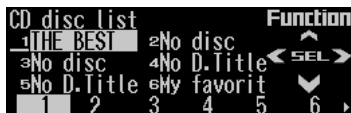

3. Press any of the buttons 1 – 6 (or 7 – 12) to select the desired disc title.

That selection will begin to play.

Note:

- You can also use ◀, ▶ and ▲ to select and play the desired disc title.
- “No D.Title” is displayed for a disc whose title has not been input.
- “No disc” is displayed next to the disc number when no disc is set in the magazine.
- You cannot display “7” – “12” when a 6-disc multi-CD player is connected.

Pausing CD playback

Pause lets you temporarily stop playback of the CD.

1. Press **FUNC** and then press **PAUSE** to select the pause mode.

2. Press **PAUSE** to turn pause on.

The light illuminates. Play of the current track pauses.

- Press **PAUSE** again to turn pause off.
- When the pause mode is exited while pause is on, “PAUSE” is displayed in the basic display.

Note:

- You can also turn pause on or off by pressing **PAUSE** in the following display.



Entering disc titles

Disc title input lets you input up to 100 CD titles up to 10 letters long (with ITS memory) into the multi-CD player. If you input a CD title, the entered title is displayed.

1. Press ▲ or ▼ to play a disc you want to enter the title.
2. Press **FUNC** and **NEXT** and then press **TTLin** to select the disc title input mode.
3. Press **ABC** to switch the character mode. Press **ABC** repeatedly to switch between the following modes: Alphabet (upper case), numbers and symbols → Alphabet (lower case) → European letters, such as those with accents (e.g. á, à, ä, ç)
 - Press 012 to switch to the numbers and symbols mode.
4. Press ▲ or ▼ to select letters, numbers and symbols.



- To insert a space, select the flashing cursor “_”.

Continued overleaf.

5. Press **▶** to move the cursor to the next character position.
 - Press **◀** to move backwards in the display.
6. Press **▶** to move the cursor to the last position and then press **▶** one more time after entering the title.
7. Press **BAND** to cancel the disc title input mode.

Note:

- When playing a CD TEXT disc on a CD TEXT compatible multi-CD player, if you switch to this mode, "No title input" is displayed and you cannot input the title.
- Titles remain in memory even after the disc has been removed from the magazine, and are recalled when the disc is reinserted.
- After the titles for 100 discs have been entered, the data for a new disc will overwrite the oldest one.

Using compression and dynamic bass emphasis

Using the COMP (compression) and DBE (dynamic bass emphasis) functions enables multi-CD player sound quality adjustment. Each of the functions enables two-step adjustment. The COMP function adjusts imbalances between loud and subdued sounds at higher volumes. DBE boosts bass levels to give a fuller sound.

1. Press **FUNC** and **NEXT** and then press **COMP** to select the compression and dynamic bass emphasis mode.
2. Press **COMP** to select the desired setting.

Press COMP repeatedly to switch between the following settings:
COMP OFF → COMP 1 → COMP 2
→ COMP OFF → DBE 1 → DBE 2

 - When this mode is exited except for "COMP OFF" is selected, "COMP" appears on the basic display.

Note:

- If the multi-CD player does not support these functions, "No COMP" is displayed when you attempt to select it.

Using ITS memory

The ITS (instant track selection) lets you make a program of favorite tracks from those in the multi-CD player magazine. After you have added your favorite tracks to the ITS memory, you can turn on ITS play and play just those selections.

Programming tracks in ITS memory

You can use ITS to enter and play back up to 99 tracks per disc for up to 100 discs (with the disc title). (With multi-CD players released before the CDX-P1250 and CDX-P650, the maximum number of programmable tracks is 24.)

1. Press **▲** or **▼** to play the CD you want to program.
2. Press **FUNC** and **NEXT** and then press **ITS.M** to select the ITS memory mode.
3. Press **◀** or **▶** to select the desired track.
4. Press **MEMO** to store the currently playing track in the ITS memory.

"Memory complete" is displayed briefly and the currently playing track is added to ITS memory.
5. Press **BAND** to cancel the ITS memory mode.

Note:

- In this mode, you can also use **▲** to store the currently playing track in the ITS memory.
- After 100 discs have been programmed, the data for a new disc will overwrite the oldest one.

Playback from ITS memory

ITS play lets you listen to the tracks that you have entered into ITS memory. When you turn on ITS play, tracks from ITS memory in the multi-CD player will begin to play.

1. Select the repeat range.

Refer to "Repeating play" on page 44.

2. Press **FUNC** and **NEXT** and then press **ITS.P** to select the ITS play mode.

3. Press **ITS.P** to turn ITS play on.

The light illuminates. Playback begins of those tracks from ITS memory within the selected repeat range: multi-CD player repeat or disc repeat.

- Press **ITS.P** again to turn ITS play off.
- When the ITS play mode is exited while ITS play is on, "ITS" appears on the basic display.

Note:

- If no track in the current play range is programmed for ITS play, "ITS empty" is displayed.

Erasing a track from ITS memory

When you want to erase a track from ITS memory, you can do so when ITS play is on.

1. Turn ITS play on while playing a CD from which you want to erase a track program from ITS memory.

Refer to "Playback from ITS memory" on this page.

2. Press **FUNC** and **NEXT** and then press **ITS.M** to select the ITS memory mode.

3. Press **◀** or **▶** to select the desired track.

4. Press **CLEAR** to erase the currently playing track from ITS memory.

The currently playing track is erased from ITS memory and playback of the next track from ITS memory begins. If there are no tracks from ITS memory in the current play range, "ITS empty" is displayed and normal play resumes.

5. Press **BAND** to cancel the ITS memory mode.

Note:

- In this mode, you can also use **▼** to erase the currently playing track from ITS memory.

Erasing a CD from ITS memory

When you want to erase all tracks of a CD from ITS memory, you can do so when ITS play is off.

1. Press **▲** or **▼** to select the CD you want to erase from ITS memory.

If ITS play is on, turn ITS play off. Refer to "Playback from ITS memory" on this page.

2. Press **FUNC** and **NEXT** and then press **ITS.M** to select the ITS memory mode.

3. Press **CLEAR** to erase all tracks on the currently playing CD from ITS memory.

"Memory deleted" is displayed briefly and all tracks on the currently playing CD are erased from ITS memory.

4. Press **BAND** to cancel the ITS memory mode.

Note:

- In this mode, you can also use **▼** to erase all tracks on the currently playing CD from ITS memory.

The following explains how to use this product to control a DAB tuner, which is sold separately. For details of DAB tuner-specific operation/features, see your DAB tuner's manual.

- This product does not have the language filter function.
- With this product, you can operate three additional functions: available service list, available PTY search, storing and recalling dynamic label.
- DAB (digital audio broadcasting) refers to digital radio that broadcasts in Canada.

Display and indicators

FORM 1



FORM 2

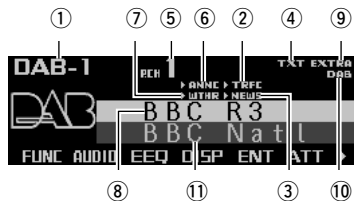

- ① Band
- ② TRFC indicator
- ③ NEWS indicator
- ④ TXT indicator
- ⑤ Preset number
- ⑥ ANNC indicator
- ⑦ WTHR indicator
- ⑧ Service label
- ⑨ EXTRA indicator
- ⑩ DAB indicator
- ⑪ Service component label

Indications that light when function is switched on

Indicator	Function
W (THR)*	Area weather flash (weather)
A (NNC)*	Announce (announce)
N (EWS)*	News flash (news)
T (RFC)*	Road traffic flash or transport flash

* If the set announcement support is received, the letters in parentheses light.

DAB status indications

Indicator	Status
EXTRA	The currently received service has a secondary service component.
TXT	The currently received service has a dynamic label.
DAB	When DAB reception is possible.

Basic operation

1. **Press SOURCE to select the DAB tuner.**
Press SOURCE until "DAB Tuner" appears.
2. **Press VOLUME to extend the VOLUME outward.**
 - When you press VOLUME, it extends outward so that it becomes easier to turn. To retract VOLUME, press it again.
3. **Turn VOLUME to adjust the volume.**
4. **Press ◀ or ▶ to select a service.**
5. **Press and hold ◀ or ▶ for one second and release to select an ensemble.**

Storing and recalling services

Storing services

1. **Press NEXT to display “1” – “6”.**
Press NEXT until “1” – “6” appears.
2. **When you find a service that you want to store in memory, press and hold any of the buttons 1 – 6 until the preset number stops flashing.**
The service is stored in memory under the selected button.

Recalling services

1. **Press NEXT to display “1” – “6”.**
Press NEXT until “1” – “6” appears.
2. **Press any of the buttons 1 – 6 to recall the service preset under that button.**

Note:

- You can also use ▲ or ▼ to recall services memorized under the buttons 1 – 6.

Changing band

- **Press BAND to select the desired band.**
Press BAND repeatedly to switch between the following bands:
DAB 1 → DAB 2 → DAB 3

Switching the display

- **Press DISP to select the desired display.**
Press DISP repeatedly to switch between the following displays:

FORM 1

SERVICE (service label) → COMPONENT (service component label) → D.TEXT (dynamic label segment head line) → ENSEMBLE (ensemble label) → PTY (PTY label)

FORM 2

SERVICE (service label) and COMPONENT (service component label) → D.TEXT (dynamic label segment head line) → SERVICE (service label) and ENSEMBLE (ensemble label) → SERVICE (service label) and PTY (PTY label)

Note:

- With a service component that has no service component label or dynamic label, the display is blank when you switch to service component label and dynamic label.

Switching the road traffic flash and transport flash on or off

1. **Press NEXT to display “TA”.**
Press NEXT until “TA” appears.
2. **Press TA to turn the road traffic flash and transport flash on.**
The “▶TRFC” or “T” indicator lights.
 - Press TA again to turn the road traffic flash and transport flash off.

Canceling road traffic flash and transport flash interruptions part way through

1. **Press NEXT to display “TA”.**
Press NEXT until “TA” appears.
2. **To cancel a road traffic flash or transport flash interruption and return to the original source, press the TA during an announcement interruption.**

Dynamic label function

Displaying dynamic labels

1. Press **NEXT** to display “D.TEXT”.
Press NEXT until “D.TEXT” appears.
2. Press **D.TEXT** to switch to the dynamic label mode.
3. Press **◀** or **▶** to recall the three latest dynamic label broadcasts from the tuner’s memory.
Pressing **◀** or **▶** switches between the four dynamic label data displays.

Note:

- Press **BAND** to cancel the dynamic label mode.
- When no dynamic label is currently being received, “No text” is displayed.
- If there is no dynamic label data stored in the tuner, **◀▶** do not operate.
- If you do not operate the function within about 60 seconds, the display is automatically returned.

Storing a dynamic label

You can store data from up to six dynamic label transmissions under the buttons **MEMO1** – **MEMO6**.

1. **Select the dynamic label you want to store in memory.**
Refer to “Displaying dynamic labels” on this page.
2. **Press and hold any of the buttons MEMO1 – MEMO6 until “DAB memo” appears to store the desired dynamic label.**
The dynamic label is stored in memory under the selected button.

Recalling a dynamic label

1. Press **NEXT** to display “D.TEXT”.
Press NEXT until “D.TEXT” appears.
2. Press **D.TEXT** to switch to the dynamic label mode
3. Press any of the buttons **MEMO1** – **MEMO6** to recall the dynamic label preset under that button.

DAB tuner function menu

The DAB tuner function menu has the following functions:



- ① **AS (announcement support)**
For operation of the announcement support, refer to “Setting the announcement support interruption” on page 52.
- ② **chLIST (preset service list)**
For operation of the preset service list, refer to “Selecting services from the preset service list” on page 52.
- ③ **S.LIST (available service list)**
For operation of the available service list, refer to “Selecting services from the available service list” on page 52.
- ④ **PTY (available PTY search)**
For operation of the available PTY search, refer to “Searching the available PTY” on page 52.
- ⑤ **P/2ND (primary/secondary)**
Press **P/2ND** repeatedly to switch to the next service component.

Note:

- If you do not operate the function within about 30 seconds, the display is automatically returned.

Setting the announcement support interruption

1. Press **FUNC** and then press **AS** to select the announcement support mode.
2. Press the corresponding button to turn the desired announcement support on.

Button	Announcement
NEWS	News flash
WTHR	Area weather flash
ANNC	Announcement

Note:

- You can also use **◀**, **▶** and **▲** to select and turn on the desired announcement.

Selecting services from the preset service list

1. Press **FUNC** and then press **chLIST** to select the preset service list mode.
2. Press any of the buttons 1 – 6 to recall the desired service.

DAB1 P.CH List				Function	
1	BAYERN 2	2	ROCK ANT	▲	
3	BAYERN 3	4	ANTENNE	◀ SEL ▶	
5	BAYERN 4	6	BR MOBIL	▼	
1	2	3	4	5	6

Note:

- You can also use **◀**, **▶** and **▲** to select and recall the desired service.

Selecting services from the available service list

The available service list lets you see the list of available services and select one of them to receive, if the currently received ensemble has multiple services.

1. Press **FUNC** and then press **S.LIST** to select the available service list mode.
2. Press **◀** or **▶** to select the desired service.

Available Service List		Function
BAYERN 2	ROCK ANT	▲
BAYERN 3	ANTENNE	◀ SEL ▶
BAYERN 4	BR MOBIL	▼
A5	chLIST S.LIST	PTY P/2ND

3. Press **▲** to receive the selected service.

Searching the available PTY

Available PTY search lets you see the list of available PTYs that is in the current ensemble and select one of them to receive.

- Available PTY search function is different from PTY search function. With this product, you can operate only the available PTY search.

1. Press **FUNC** and then press **PTY** to select the available PTY search mode.
2. Press **◀** or **▶** to select the desired PTY.

Available PTY search		Function
News	Rock Mus	▲
Classic	Info	◀ SEL ▶
Sport	Jazz	▼
A5	chLIST S.LIST	PTY P/2ND

3. Press **▲** to start the PTY search.

DAB receives the desired PTY service.

Note:

- The PTY method displayed is narrow.
- If there is no available PTY in the current ensemble, you cannot switch to the available PTY search mode.
- If no service broadcasting the selected programming type is found, "Not found" is displayed briefly, and the DAB tuner returns to the previous service.

The following explains how to use this product to control a TV tuner, which is sold separately. For details of TV tuner-specific operation/features, see your TV tuner's manual.

- With this product, you can operate preset channel list as one additional function.

Display and indicators

FORM 1



FORM 2

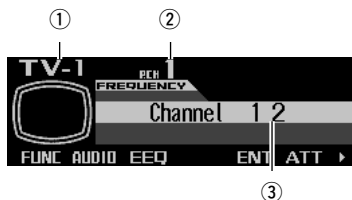

- ① Band
- ② Preset number
- ③ Channel

Basic operation

1. **Press SOURCE to select the TV tuner.**
Press SOURCE until "Television" appears.
2. **Press VOLUME to extend the VOLUME outward.**
 - When you press VOLUME, it extends forward so that it becomes easier to turn. To retract VOLUME, press it again.
3. **Turn VOLUME to adjust the volume.**
4. **Press ◀ or ▶ to tune in to a station.**
 - If you press and hold ◀ or ▶ for about one second and then release, you can perform seek tuning.

Storing and recalling broadcast stations

If you press any of the buttons 1 – 6 (or 7 – 12), you can easily store up to 12 broadcast stations for later recall.

Storing broadcast stations

1. **Press NEXT to display "1" – "6" (or "7" – "12").**
Press NEXT until "1" – "6" (or "7" – "12") appears.
2. **When you find a station that you want to store in memory, press and hold any of the buttons 1 – 6 (or 7 – 12) until the preset number stops flashing.**
The station is stored in memory under the selected button.

Note:

- Up to 12 stations can be memorized in one band.
- This product allows you to store and recall directly using preset channels 7 – 12.

Recalling broadcast stations

1. Press **NEXT** to display “1” – “6” (or “7” – “12”).
Press **NEXT** until “1” – “6” (or “7” – “12”) appears.
2. Press any of the buttons 1 – 6 (or 7 – 12) to recall the station preset under that button.

Note:

- You can also use ▲ or ▼ to recall broadcast stations memorized under the buttons 1 – 12.

Changing band

- Press **BAND** to select the desired band.
Press **BAND** repeatedly to switch between the following bands:
TV 1 → TV 2

TV tuner function menu

The TV tuner function menu has the following functions:

BSSM chLIST

①

②

- ① **BSSM (best stations sequential memory)**
Press **BSSM** repeatedly to turn **BSSM** on or off.
When finished, the display switches to the preset channel list mode.
- ② **chLIST (preset channel list)**
For operation of the preset channel list, refer to “Selecting channels from the preset channel list” on this page.

Note:

- If you do not operate the function within about 30 seconds, the display is automatically returned.

Selecting channels from the preset channel list

The preset channel list lets you see the list of preset channels and select one of them to receive.

1. Press **FUNC** and then press **chLIST** to select the preset channel list mode.
2. Press **NEXT** to switch between “1” – “6” and “7” – “12”.



3. Press any of the buttons 1 – 6 (7 – 12) to recall the desired channel.

Note:

- You can also use ◀, ▶ and ▲ to select and recall the desired channel.

Adjusting the audio easily

The following functions let you easily adjust your audio system to match the car interior acoustic characteristics which vary depending on the type of car.

- Recalling equalizer curves (EEQ)
- Using position selector (POSI)
- Using time alignment (T.AL1)
- Adjusting equalizer curves (EQ1)

Adjusting the audio finely

By carrying out the following settings/adjustments in order, you can create a finely-tuned sound field effortlessly.

- Using position selector (POSI)
- Using time alignment (T.AL1)
- Adjusting time alignment (T.AL2)
- Using subwoofer output (SW1)
- Adjusting subwoofer settings (SW2)
- Setting the high pass filter for front speakers (HPF F)
- Setting the high pass filter for rear speakers (HPF R)
- Using balance adjustment (F/B)
- Creating the auto-equalizer curve (A.EQ)
- Recalling equalizer curves (EEQ)
- Adjusting equalizer curves (EQ1)
- Adjusting 13-band graphic equalizer (EQ2)

Extra functions

These functions are helpful in adjusting the sound to suit your system or your personal preferences.

- Using loudness (LOUD)
- Using sound field control, octaver and BBE sound (SFC)
- Using automatic sound levelizer (ASL)
- Adjusting source levels (SLA)
- Switching the digital attenuator (D.ATT)

Recalling equalizer curves

The graphic equalizer lets you adjust equalization to match the car interior acoustic characteristics as desired. There are seven stored equalizer curves which you can easily recall at any time.

1. Press **EEQ** to switch to the easy equalizer mode.
2. Press **NEXT** to switch between “CSTM2” and the other selections (curves).
3. Press the corresponding button to select the desired equalizer curve.

Button	Equalizer curve
S.BASS	Super bass
PWRFL	Powerful
NATRL	Natural
VOCAL	Vocal
FLAT	Flat
CSTM1	Custom1
CSTM2	Custom2

- “CUSTOM1” and “CUSTOM2” are adjusted equalizer curves that you can create for yourself. (Refer to “Adjusting 13-band graphic equalizer” on page 57.)
- When “FLAT” is selected the equalizer makes no supplement or correction to the sound. This is useful for checking the effect of the equalizer curves by switching alternatively between “FLAT” and a set equalizer curve.

Note:

- You can also use ◀ and ▶ to select the desired equalizer curve.
- If you do not operate the function within about eight seconds, the display is automatically returned.

Audio menu

The audio menu has the following functions:

F/B LOUD SFC EQ1 EQ2 ASL ▶

POS1 T.AL1 T.AL2 SW1 SW2 HPFF ▶

HPFR SLA A.EQ D.ATT ▶

Note:

- If you do not operate the function within about 30 seconds, the display is automatically returned. (When you select the 13-band graphic equalizer mode (EQ2) or the time alignment adjustment mode (T.AL2), the display is not returned automatically.)
- “T.AL2” is displayed only when you select “FL” or “FR” in the position selector mode (POS1).
- “SW2” is displayed only when the subwoofer output is on in the subwoofer output mode (SW1).
- “SLA” is not displayed when you select FM tuner as the source.
- “A.EQ” is displayed after the auto-equalizer curve has been set.

Using balance adjustment

You can select a fader/balance setting that provides an ideal listening environment in all occupied seats.

1. Press **AUDIO** to select the fader/balance mode.
2. Press **▲** or **▼** to adjust front/rear speaker balance.

Each press of **▲** or **▼** moves the front/rear speaker balance towards the front or the rear.

- “FADER F25” – “FADER R25” is displayed as the front/rear speaker balance moves from front to rear.
- “FADER FR00” is the proper setting when only two speakers are used.

3. Press **◀** or **▶** to adjust left/right speaker balance.

Each press of **◀** or **▶** moves the left/right speaker balance towards the left or the right.

- “BALANCE L25” – “BALANCE R25” is displayed as the left/right speaker balance moves from left to right.

Using loudness

Loudness compensates for deficiencies in the low- and high-sound ranges at low volume.

1. Press **AUDIO** and then press **LOUD** to select the loudness mode.
2. Press **LOUD** to turn the loudness on.
 - “LOUDNESS ON” appears in the display.
 - Press **LOUD** again to turn loudness off.

Using sound field control, octaver and BBE® sound

SFC (sound field control) incorporates four programs reproducing the typical sound field of a studio, club, concert hall or dome. This function makes it possible to reproduce the realistic sound fields of the four programs in your car. Octaver makes the bass sound louder. Playback very close to the original sound can be obtained by correction with a combination of phase compensation and high-range boost for the delay of the high-frequency components and the amplitude deviation occurring during playback. This function makes it possible to reproduce the dynamic sound field as if you are listening to a live performance.

Note:

- Manufactured under license from BBE Sound, Inc. The mark BBE is a trademark of BBE Sound, Inc.

Recalling sound field programs

1. Press **AUDIO** and then press **SFC** to select the sound field control mode.
2. Press the corresponding button to select the desired sound field program.

Button	Effect
STUDIO	Studio
CLUB	Club
HALL	Concert hall
DOME	Dome
OCT	Octaver 1 and 2
BBE	BBE

- Press the same button again to cancel the selected sound field program.

Switching the octaver setting

You can switch the octaver setting. "OCTAVER2" has a stronger effect "OCTAVER1".

1. Press **AUDIO** and **SFC** and then press **OCT** to select octaver.
2. Press **▲** or **▼** to switch the octaver setting.

Each press of **▲** or **▼** switches the octaver setting between 1 and 2.

Adjusting BBE sound level

For BBE sound processing technology, you can adjust the level of BBE.

1. Press **AUDIO** and **SFC** and then press **BBE** to select BBE.
2. Press **▲** or **▼** to adjust the level of BBE.

Each press of **▲** or **▼** increases or decreases the level of BBE.

- "+4" – "-4" is displayed as the level is increased or decreased.

Adjusting equalizer curves

The factory supplied equalizer curves, with the exception of "FLAT", can be adjusted to a fine degree (nuance control).

1. Press **AUDIO** and then press **EQ1** to select the graphic equalizer mode.
2. Press **▲** or **▼** to adjust the equalizer curve.

Each press of **▲** or **▼** increases or decreases the equalizer curve respectively.

- "+6" – "-6" is displayed as the equalizer curve is increased or decreased.

Note:

- The actual range of the adjustment differs depending on which equalizer curve is selected.
- The equalizer curve with all frequencies set to 0 cannot be adjusted.
- You can use **◀** and **▶** to select the desired equalizer curve.

Adjusting 13-band graphic equalizer

For "CUSTOM1" and "CUSTOM2" equalizer curves, you can adjust the level of each band.

- A separate "CUSTOM1" curve can be created for each source. (The built-in CD (MP3) and the multi-CD players are set to the same equalizer adjustment setting automatically.) If you make adjustments when a curve other than "CUSTOM2" is selected, the equalizer curve settings will be memorized in "CUSTOM1".
- A "CUSTOM2" curve can be created common to all sources. If you make adjustments when the "CUSTOM2" curve is selected, the "CUSTOM2" curve will be updated.

1. **Recall the equalizer curve you want to adjust.**
Refer to "Recalling equalizer curves" on page 55.
2. **Press AUDIO and then press EQ2 to select the 13-band graphic equalizer mode.**
3. **Press ◀ or ▶ to select the equalizer band to be adjusted.**

Each press of ◀ or ▶ selects equalizer bands in the following order:
 50 ↔ 80 ↔ 125 ↔ 200 ↔ 315 ↔ 500
 ↔ 800 ↔ 1.25k ↔ 2k ↔ 3.15k ↔ 5k
 ↔ 8k ↔ 12.5k (Hz)

4. **Press ▲ or ▼ to adjust the level of the equalizer band.**

Each press of ▲ or ▼ increases or decreases the level of the equalizer band.

- "+6" – "–6" is displayed as the level is increased or decreased.
- You can then select another band and adjust the level.

Using automatic sound levelizer

During driving, noise in the car changes according to the driving speed and road conditions. The automatic sound levelizer (ASL) monitors such varying noise and automatically increases the volume level, if the noise becomes greater. The sensitivity (variation of volume level to noise level) of ASL can be set to one of five levels.

1. **Press AUDIO and then press ASL to select the automatic sound levelizer mode.**
2. **Press ASL to set the automatic sound levelizer sensitivity.**
Press ASL repeatedly to switch between the following settings:
 OFF (off) → Low (low) → Mid-Low (mid-low)
 → Mid (mid) → Mid-High (mid-high)
 → High (high)
 - When the ASL mode is exited except for "OFF" is selected, "ASL" appears on the basic display.

Using position selector

One way to assure a more natural sound is to clearly position the stereo image, putting you right in the center of the sound field. The position selector function lets you automatically adjust the speakers' output levels and inserts a delay time to match the number and position of occupied seats. The result is a natural sound regardless of where you are seated.

1. **Press AUDIO and NEXT and then press POSI to select the position selector mode.**
2. **Press the corresponding button to select a listening position.**

Button	Position
FL	Front seat left
FR	Front seat right
FRONT	Front seats
ALL	All seats

- Press the same button again to cancel the selected listening position.

Note:

- You can also use ▲, ▼, ◀ or ▶ to select the listening position.

Button	Position
◀	Front seat left
▶	Front seat right
▲	Front seats
▼	All seats

Using time alignment

The time alignment lets you adjust the distance between each speaker and the listening position to match the type of car. There are five types of car stored which you can easily recall at any time.

1. Press **AUDIO** and **NEXT** and then press **T.AL1** to select the time alignment mode.
2. Press the corresponding button to select the type of car.

Button	Type of car
SEDAN	Sedan
WAGON	Wagon
M.VAN	Mini van
SUV	SUV
CUSTM	Custom

- “Custom” is an adjusted time alignment that you can create for yourself.

Adjusting time alignment

For “Custom” time alignment, you can adjust the distance between each speaker and the selected position.

1. Press **AUDIO** and **NEXT** and then press **T.AL2** to select the time alignment adjustment mode.
2. Press the corresponding button to select a unit of distance.

Button	Unit of distance
cm	Centimeter
inch	Inch

3. Press **◀** or **▶** to select the speaker to be adjusted.

Each press of **◀** or **▶** selects speakers in the following order:

Front Left (front left) ↔ Front Right (front right) ↔ Rear Right (rear right) ↔ Rear Left (rear left) ↔ Sub. W (subwoofer)

- You cannot select “SUB.W” when the subwoofer output is off.

4. Press **▲** or **▼** to adjust the distance between the selected speaker and the listening position.

Each press of **▲** or **▼** increases or decreases the distance.

- “400.0cm” – “0.0cm” is displayed as the distance is increased or decreased, if you have selected centimeters (cm).
- “160inch” – “0inch” is displayed as the distance is increased or decreased, if you have selected inches.
- You can adjust the distance for the other speakers in the same way.

Note:

- “T.AL2” is not displayed when neither “FL” or “FR” is selected in the position selector mode (POS1). If “FL” or “FR” is not selected, “T.AL2” is inactive.

Using subwoofer output

This product is equipped with a subwoofer output which can be switched on or off. When a subwoofer is connected to this product, turn the subwoofer output on.

The subwoofer output phase can be switched between normal and reverse.

1. Press **AUDIO** and **NEXT** and then press **SW1** to select the subwoofer output mode.
2. Press **SW1** to turn the subwoofer output on.

“SUB. W ON” appears in the display.

- Press **SW1** again to turn subwoofer output off.

3. Press **◀** or **▶** to select the subwoofer output phase.

Press **◀** to select reverse phase. Press **▶** to select normal phase.

Adjusting subwoofer settings

When the subwoofer output is on, you can adjust the cut-off frequency and the output level of the subwoofer.

1. Press **AUDIO** and **NEXT** and then press **SW2** to select the subwoofer setting mode.
2. Press **◀** or **▶** to select the cut-off frequency.
Each press of **◀** or **▶** selects cut-off frequencies in the following order:
50 ↔ 63 ↔ 80 ↔ 100 ↔ 125 (Hz)
3. Press **▲** or **▼** to adjust the output level of the subwoofer.
Each press of **▲** or **▼** increases or decreases the level of the subwoofer.
 - “+6” – “-24” is displayed as the level is increased or decreased.

Note:

- “SW2” is not displayed when the subwoofer output is off in the subwoofer output mode (SW1). In this case, this mode is inactive.

Using the high pass filter

When the subwoofer is connected and you do not want low sound to play from the front or rear speakers, turn the high pass filter on. Only frequencies higher than those in the selected range will be output from the front or rear speakers.

Setting the high pass filter for front speakers

1. Press **AUDIO** and **NEXT** and then press **HPF F** to select the high pass filter mode.
2. Press **HPF F** to turn the high pass filter on.
“HPF ON” appears in the display.
 - Press **HPF F** again to turn the high pass filter off.

3. Press **◀** or **▶** to select a high pass filter range.

Each press of **◀** or **▶** selects frequencies in the following order:
50 ↔ 63 ↔ 80 ↔ 100 ↔ 125 (Hz)

Setting the high pass filter for rear speakers

1. Press **AUDIO** and then press **NEXT** twice.
2. Press **HPF R** to select the high pass filter mode.
3. Press **HPF R** to turn the high pass filter on.
“HPF ON” appears in the display.
 - Press **HPF R** again to turn the high pass filter off.
4. Press **◀** or **▶** to select a high pass filter range.

Each press of **◀** or **▶** selects frequencies in the following order:
50 ↔ 63 ↔ 80 ↔ 100 ↔ 125 (Hz)

Adjusting source levels

SLA (source level adjustment) lets you adjust the volume level of each source to prevent radical changes in volume when switching between sources.

- Settings are based on the FM tuner volume level, which remains unchanged.
1. **Compare the FM tuner volume level with the level of the source you want to adjust (e.g., built-in CD player).**

2. **Press AUDIO and then press NEXT twice.**
3. **Press SLA to select the SLA mode.**

4. **Press ▲ or ▼ to adjust the source volume.**

Each press of ▲ or ▼ increases or decreases the source volume.

- “+4” – “-4” is displayed as the source volume is increased or decreased.

Note:

- Since the FM tuner volume is the control, it is not possible to apply source level adjustments to the FM tuner.
- The AM tuner volume level can also be adjusted using source level adjustment.
- The built-in CD (MP3) and the multi-CD players are both set to the same source level adjustment volume automatically.

Using the auto-equalizer

The auto-equalizer is the equalizer curve created by auto-equalizing. (Refer to “Creating the auto-equalizer curve” on this page.)

You can turn the auto-equalizer on or off.

1. **Press AUDIO and then press NEXT twice.**
2. **Press A.EQ to select the auto-equalizer on/off mode.**

3. **Press A.EQ to turn the auto-equalizer on.**
“AUTO EQ ON” appears in the display.
 - Press A.EQ again to turn auto-equalizer off.

Note:

- “A.EQ” is not displayed if auto-equalizing has not been carried out. In this case, this mode is inactive.

Switching the digital attenuator

When listening to a CD or other source on which the recording level is high, setting the equalizer curve level to high may result in distortion.

You can switch the digital attenuator to low to reduce distortion.

- Sound quality is better at the high setting, so this is the setting usually used.

1. **Press AUDIO and then press NEXT twice.**
2. **Press D.ATT to select the digital attenuator mode.**
3. **Press the corresponding button to select the digital attenuator level.**

Button	Level
LOW	Low
HIGH	High

Creating the auto-equalizer curve

The auto-equalizer automatically measures car interior acoustic characteristics, and then creates the auto-equalizer curve based on that information.

WARNING:

- To prevent accidents, never carry out auto-equalizing while driving. When this function measures the car interior acoustic characteristics to create an auto-equalizer curve, a loud measurement tone (noise) may be output from the speakers.

PRECAUTION:

- Carrying out auto-equalizing under the following conditions may damage the speakers. Be sure to check conditions thoroughly before carrying out auto-equalizing.
 - When speakers are incorrectly connected. (e.g., When a rear speaker is connected to a subwoofer output.)
 - When a speaker is connected to a power amp delivering output higher than the speaker's maximum input power capability.
- If the microphone is placed in an unsuitable position the measurement tone may become loud and measurement may take a long time, resulting in a drain on battery power. Be sure to place the microphone in the specified location. (Refer to "Carrying out auto-equalizing.")

Before operating the auto-equalization function

- Carry out auto-equalizing in as quiet a place as possible, with the car engine and air conditioning switched off. Also cut power to car phones or portable telephones in the car, or remove from the car before carrying out auto-equalizing. Sounds other than the measurement tone (surrounding sounds, engine sound, telephones ringing etc.) may prevent correct measurement of car interior acoustic characteristics.
- Be sure to carry out auto-equalizing using the supplied microphone. Using another microphone may prevent measurement, or result in incorrect measurement of car interior acoustic characteristics.
- Neither front nor rear speaker is connected, auto-equalizing cannot be carried out.
- When this product is connected to a power amp with input level control, auto-equalizing may not be possible if you lower power amp input level. Set the power amp's input level to the standard position.

- Auto-equalizing changes the audio settings as below:
 - The fader/balance settings return to the center position. (Refer to page 56.)
 - The graphic equalizer curve switches to "FLAT". (Refer to page 55.)
 - When a subwoofer is connected to this product, it will be adjusted automatically either subwoofer output and high pass filter setting for rear speaker.
- If you carry out auto-equalizing when an auto-equalizer curve already exists, the previous curve will be erased.

Carrying out auto-equalizing

1. **Stop the car in a place that is as quiet as possible, close all doors, windows and the sun roof, and then turn the engine off.**

If the engine is left running, engine noise may prevent correct auto-equalizing.

2. **Fix the supplied microphone in the center of the headrest of the driver's seat, facing forward, using the belt (sold separately).**

The auto-equalizer curve may differ depending on where you place the microphone. If desired, place the microphone on the front passenger seat to carry out auto-equalizing.

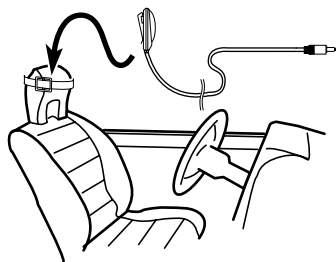

Continued overleaf.

Audio Adjustments

3. Turn the ignition switch to ON or ACC.

If the car's air conditioner or heater is turned on, turn it off. Noise from the fan in the air conditioner or heater may prevent correct auto-equalizing.

- Press SOURCE to turn the source on if this product is turned off.

4. Select the position for the seat on which the microphone is placed.

Refer to "Using position selector" on page 58.

- If no position is selected before you start auto-equalizing, "FL" is selected automatically.

5. Press and hold SOURCE to turn the source off.

6. Press and hold $\rightarrow 2$ to enter the auto-equalizer measurement mode.

- When the source is off, you can check the location of " $\rightarrow 2$ " by turning on the feature demo.

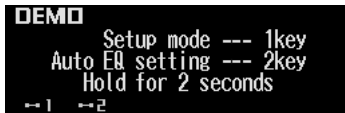

7. Plug the microphone into the microphone input jack on this product.

Remove the microphone input jack cap and plug in the microphone.

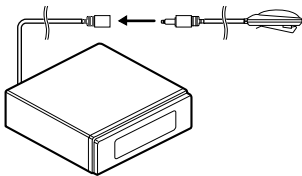

8. Press A.EQ to start the auto-equalizing.

9. Get out of the car and close the door within 10 seconds when the 10-second count-down starts.

The measurement tone (noise) is output from the speakers, and auto-equalizing (acoustic characteristics measurement and compensation) begins.

- When all speakers are connected, auto-equalizing is completed in about four minutes.
- To cancel auto-equalizing part way through, press any button.

10. When auto-equalizing is completed, "Complete" is displayed.

When correct measurement of car interior acoustic characteristics is not possible, an error message is displayed. (Refer to "Understanding auto-equalizing error messages" on page 73.)

11. Press any button to cancel the auto-equalizer mode.

12. Store the microphone and microphone input jack carefully in the safe place.

Store the microphone carefully in the glove compartment or other safe place. If the microphone is subjected to direct sunlight for an extended period, high temperatures may cause distortion, color change or malfunction.

WARNING:

- After attaching the microphone input jack cap, store it in a safe place. If the microphone input jack cable tangles with the accelerator pedal, it can hamper driving and be extremely dangerous.

Initial settings menu

The initial settings menu has the following functions:



Initial settings menu operation

You can operate the initial settings menu only when the source is off.

1. Press and hold **SOURCE** to turn the source off.
2. Press and hold **↔ 1** to enter the initial settings menu.
 - When the source is off, you can check the location of “↔ 1” by turning on the feature demo.

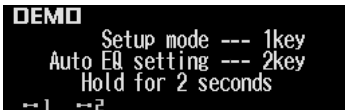

Note:

- Press **BAND** to cancel the initial settings menu.

Using reverse mode

If you do not carry out an operation within about 30 seconds, screen indications will start to reverse, and then continue reversing every 10 seconds.

You can turn the reverse mode on or off.

1. With the source turned off, press and hold **↔ 1** to select the reverse mode.
2. Press **REV** to turn the reverse mode on.

“ON” appears in the display.

 - Press **REV** again to turn the reverse mode off.

Using the feature demo

The feature demo automatically starts when power to this product is switched off while the ignition switch is set to ACC or ON. You can turn the feature demo on or off.

1. With the source turned off, press and hold **↔ 1**.
2. Press **F.DEMO** to select the feature demo mode.
3. Press **F.DEMO** to turn the feature demo on.

“ON” appears in the display.

 - Press **F.DEMO** again to turn the feature demo off.

Note:

- The red lead (ACC) of this product should be connected to a terminal coupled with ignition switch ON/OFF operations. If this is not done, the vehicle battery may be drained.

Switching the auxiliary setting

It is possible to use auxiliary equipment with this product.

Turn the auxiliary setting on when using auxiliary equipment connected to this product.

1. With the source turned off, press and hold **↔ 1**.
2. Press **AUX** to select the AUX mode.
3. Press **AUX** to turn AUX on.

“ON” appears in the display.

 - Press **AUX** again to turn AUX off.

Switching the telephone muting/attenuation setting

When a call is made or received using a cellular phone connected to this product, the product can be set to either mute or attenuate the audio output.

1. With the source turned off, press and hold **1**.
2. Press **MUTE.S** to select the telephone muting/attenuation mode.
3. Press **MUTE.S** to select the desired setting.

Press **MUTE.S** repeatedly to switch between the following settings:

TEL mute → 10dB ATT → 20dB ATT

Sound from this product is muted or attenuated automatically when a call is made or received using a connected cellular telephone.

- “20dB ATT” has a stronger effect than “10dB ATT”, and “TEL mute” has a stronger effect than “20dB ATT”.

Formatting the “Memory Stick”

When this product can not read an inserted “Memory Stick”, the “Memory Stick” must be formatted by this product. Formatting a “Memory Stick” erases all data stored on it.

Note:

- When formatting, all data will be erased. Always confirm the contents of the “Memory Stick” before erasing.
- When purchasing a commercially available “Memory Stick”, it is already FAT-formatted, so further formatting is unnecessary.

1. With the source turned off, press and hold **1**.
2. Press **UTLTY** to select the format mode.
3. Press **OPEN** to open the front panel.
4. Insert a “Memory Stick” into the MS loading slot.

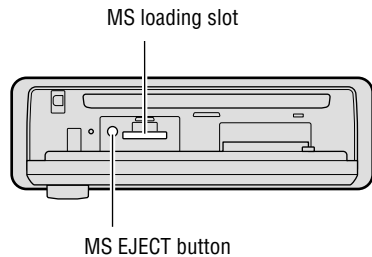

5. Close the front panel.
6. Press **▲** to format a “Memory Stick”.
The confirmation screen appears.
7. Press **◀** and then press **▲** to select “Y”.
When formatting is completed, “Finished” is displayed.
 - If you press **▶** and **▲** to select “N”, formatting will be terminated.

Setting the warning tone

The warning tone sounds to remind you to detach the front panel. (Refer to page 13.) You can turn the warning tone function on or off.

1. **With the source turned off, press and hold  1.**
2. **Press NEXT and then press DT-WRN to select the warning tone mode.**
3. **Press DT-WRN to turn the warning tone on.**
 - “ON” appears in the display.
 - Press DT-WRN again to turn the warning tone off.

Attenuating volume

The attenuator lets you lower the volume level quickly (by about 90%).

- **Press ATT to turn the attenuator on.**
“ATT” appears in the display.
- Press ATT again to turn the attenuator off and return to the original volume level.

Changing the display form

This product is equipped with two basic displays. You can select the desired display.

1. **Press NEXT to display “C.MENU”.**
Press NEXT until “C.MENU” appears.
2. **Press C.MENU and then press D.FORM to select the display form mode.**
3. **Press either FORM1 or FORM2 to select the desired display form.**

Adjusting the brightness

Display brightness adjustment lets you adjust the display for easier viewing when lighting conditions change.

1. **Press NEXT to display “C.MENU”.**
Press NEXT until “C.MENU” appears.
2. **Press C.MENU and then press BRGHT to select the brightness mode.**
3. **Press ◀ or ▶ to adjust the brightness.**

Each press of ◀ or ▶ increases or decreases the brightness.

- “00” – “31” is displayed as the brightness is increased or decreased.

Switching the dimmer setting

To prevent the display from being too bright at night, the display is automatically dimmed when the car’s headlights are turned on. You can switch the dimmer on or off.

1. **Press NEXT to display “C.MENU”.**
Press NEXT until “C.MENU” appears.
2. **Press C.MENU and then press DMMER to select the dimmer mode.**
3. **Press DMMER to turn the dimmer on.**
“ON” appears on the display.
 - Press DMMER again to turn the dimmer off.

Selecting the wall paper pattern

The wall paper pattern is only for display form 2 “FORM2”, and there are three patterns to choose from.

- When you select “FORM1”, “PTRN” is not displayed and this mode is inactive.
1. **Press NEXT to display “C.MENU”.**
Press NEXT until “C.MENU” appears.
 2. **Press C.MENU and then press PTRN to select the wall paper pattern mode.**
 3. **Press any of the buttons A – C to select the desired pattern.**

Setting the entertainment display

You can change the display to the movie screens, the spectrum analyzer displays, etc., while listening to any source.

Setting the movie screen

There are four stored movie screens to select from.

1. Press **ENT** and then press **MOVIE** to select the movie mode.
2. Press any of the buttons **MOVIE1** – **MOVIE4** or **ALL** to select the desired movie.
 - When you press **ALL**, you can display movies 1 to 4 sequentially.

Note:

- The movie screen will disappear temporarily when you perform other operations, but will be displayed again after three seconds.

Setting the spectrum analyzer display

There are four stored spectrum analyzer displays to select from.

1. Press **ENT** and then press **S/A** to select the spectrum analyzer mode.
2. Press any of the buttons **S/A1** – **S/A4** to select the desired spectrum analyzer.

Note:

- The spectrum analyzer display will disappear temporarily when you perform other operations, but will be displayed again after three seconds.

Setting the ASL display

You can display the ASL effect level. (Refer to page 58.)

- Press **ENT** and then press **ASL** to select the ASL display.

Note:

- The ASL display will disappear temporarily when you perform other operations, but will be displayed again after three seconds.

Setting the background visual

The background visuals are only for display form 1 "FORM1". There are five stored background visuals to select from.

- When you select "FORM2", "BG" is not displayed and this mode is inactive.

1. Press **ENT** and **BG** and then press **BGV** to select the background visual mode.
2. Press any of the buttons **BGV1** – **BGV5** to select the desired visual.

Setting the background still picture

The background still pictures are only for the display form 1 "FORM1". There are 12 stored background still pictures to select from.

- When you select "FORM2", "BG" is not displayed and this mode is inactive.

1. Press **ENT** and **BG** and then press **BGP** to select the background still picture mode.
2. Press **NEXT** to switch between "BGP1" – "BGP6" and "BGP7" – "BGP12".
3. Press any of the buttons **BGP1** – **BGP6** (or **BGP7** – **BGP12**) to select the desired picture.

Canceling the entertainment display

You can cancel the entertainment display (the movie screens, the spectrum analyzer displays, etc.).

- Press **ENT** and then press **OFF** to cancel the entertainment display.

Using the AUX source

An IP-BUS-RCA interconnector such as the CD-RB20 or CD-RB10 (sold separately) lets you connect this product to auxiliary equipment featuring RCA output. For more details, refer to the IP-BUS-RCA interconnector's owner's manual.

Selecting AUX as the source

- Press **SOURCE** to select **AUX** as the source.

Press **SOURCE** until "AUX" appears.

Entering the AUX title

The title displayed for the AUX source can be changed.

1. Press **SOURCE** to select **AUX** as the source.

Press **SOURCE** until "AUX" appears.

2. Press **FUNC** and then press **TTLin** to select the **AUX** title input mode.

Refer to "Entering disc titles" on page 46, and perform procedures 3 to 7 in the same way.

Note:

- Even if you do not press **TTLin** you can enter the title, but you will not be able to change the character types.

Using the telephone muting/attenuation

Sound from this product is muted or attenuated automatically when a call is made or received using a connected cellular telephone.

Note:

- The sound turns off, "MUTE" or "ATT" is displayed and no audio adjustments, except volume control, are possible.
- Operation returns to normal when the phone call is ended.

CD player and care

- Use only CDs that carry either of the two Compact Disc Digital Audio marks shown below.



- Use only normal, round CDs. If you insert irregular, non-round, shaped CDs they may jam in the CD player or not play properly.



- Check all CDs for cracks, scratches or warping before playing. CDs that are cracked, scratched or warped may not play properly. Do not use such discs.
- Avoid touching the recorded (non-printed side) surface when handling the disc.
- Store discs in their cases when not in use.
- Keep discs out of direct sunlight and do not expose the discs to high temperatures.
- Do not attach labels, write on or apply chemicals to the surface of the discs.
- To clean dirt from a CD, wipe the disc with a soft cloth outward from the center of the disc.



- If the heater is used in cold weather, moisture may form on components inside the CD player. Condensation may cause the CD player not to operate properly. If you think that condensation is a problem, turn off the CD player for an hour or so to allow the CD player to dry out and wipe any damp discs with a soft cloth to remove the moisture.
- Road shocks may interrupt CD playback.
- SACD (Super Audio CD) refers to the ability to play back only the CD layer on a hybrid disk.

CD-R and CD-RW discs

- CD-R/CD-RW discs that have not been subject to the "finalize process" (a process that allows them to be played back on a conventional CD player) can not be played back.
- It may not be possible to play back CD-R/CD-RW discs recorded on a music CD recorder or a personal computer because of disc characteristics, scratches or dirt on the disc, or dirt, condensation, etc. on the lens of this unit.
- Playback of discs recorded on a personal computer may not be possible depending on the application settings and the environment. Please record with the correct format. (For details, contact the manufacturer of the application.)
- Playback of CD-R/CD-RW discs may become impossible in case of direct exposure to sunlight, high temperatures, or the storage conditions in the car.
- Titles and other text information recorded on a CD-R/CD-RW disc may not be displayed by this product (in the case of audio data (CD-DA)).
- This product conforms to the track skip function of the CD-R/CD-RW disc. The tracks containing the track skip information are skipped over automatically (in the case of audio data (CD-DA)).
- If you insert a CD-RW disc into this product, load time to playback will be longer than for a conventional CD or CD-R disc.
- Read the precautions accompanying the CD-R/CD-RW discs before use.
- Recordings on CD-R/CD-RW can not be played back using the DDCD (Double Density CD) system.

MP3 files

- MP3 is short for MPEG Audio Layer 3 and refers to an audio compression technology standard.
- This product allows playback of MP3 files on CD-ROM, CD-R and CD-RW discs. Disc recordings compatible with ISO9660 level 1 and level 2 can be played back. Correspondence to extended format is made with the following conditions.
Joliet: Correspondence only to the 8.3 format.
Romeo: Correspondence to folder names with up to 64 characters and file names with up to 63 characters (including the extension).
- Discs that have been recorded in multiple recording sessions are replayed in their first session form only.
- Files are compatible with the ID3 Tag Ver. 1.0 and Ver. 1.1 formats for display of album (disc title), track (track title) and artist (track artist).
- Only when MP3 files of 32, 44.1 and 48 kHz frequencies are played back, the emphasis function is valid. (22.05, 24, 32, 44.1, 48 kHz sampling frequencies can be played back.)
- MP3 files are not compatible with packet write data transfer.
- There is no m3u playlist compatibility.
- There is no compatibility with the MP3i (MP3 interactive) or mp3PRO format.

Precaution:

- When naming an MP3 file, add the corresponding filename extension (.mp3).
- This product plays back files with the filename extension (.mp3) as an MP3 file. To prevent noise and malfunctions, do not use this extension for files other than MP3 files.

About folders and MP3 files

- An outline of a CD-ROM with MP3 files on it is shown below. Subfolders are shown as folders in the folder currently selected. (In the case shown, 01S is a subfolder of the 01 folder.)

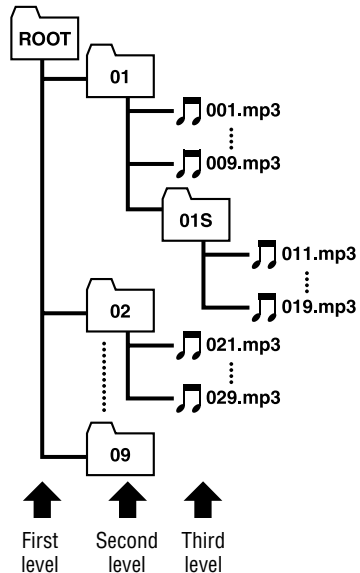

Note:

- The elapsed playback time for the data track of a Mixed Mode CD will be displayed, but no sound will be output. Only music tracks will be played back.
- It is not possible to check folders that do not include MP3 files.
- MP3 files in up to 8 tiers of folders can be played back. However, there is a delay in the start of playback on discs with numerous tiers. For this reason we recommend creating discs with no more than 2 tiers.

“Memory Stick” player and care

- Use only “Memory Stick” (“MagicGate Memory Stick”) with the mark shown below.



- “Memory Stick” with the following mark can not be used.



- The maximum storage capacity of the “MG Memory Stick” compatible with this product is 128 MB.
- When the erasure prevention switch is set to LOCK, you can not record, edit or erase.

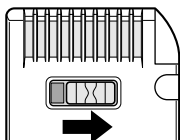

- Do not touch the terminals with your fingers or metal objects.



- Do not remove the “Memory Stick” while writing (when the access lamp is lights), as this could damage data.

- Do not place the “Memory Stick” in a place where it may be subject to static or electrical noise, as this can damage data.
- The “Memory Stick” should be formatted by using this product or the formatting device for the “MG Memory Stick”. If the “Memory Stick” is formatted with Windows Explorer, data can not be played back on this product.
- Store the “Memory Stick” away from direct sunlight and high temperatures.
- Keep the “Memory Stick” away from the source of magnetic interference, such as TVs or audio speakers.
- Keep the “Memory Stick” in its case.
- Paste each “Memory Stick” label to a proper location. You may be unable to eject a “Memory Stick” if its label is pasted in layer or to a wrong location.
- Do not use the “Memory Stick” whose label is partially unstuck or floated. Replace such label before using the “Memory Stick”, otherwise the label may be caught midway to prevent the “Memory Stick” from being ejected.
- If the surface of the “Memory Stick” is tainted, wipe it with clean soft cloth.
- Do not apply volatile chemicals such as benzine or thinner to the “Memory Stick”.

Understanding auto-equalizing error messages

When correct measurement of car interior acoustic characteristics is not possible using the auto-equalizer, an error message may appear on the display. If an error message appears on the display, refer to the table below to see what the problem is and the suggested method of correcting the problem. After checking, try again.

Display	Cause	Remedy
ERROR CHECK MIC	Microphone is not connected.	Plug the supplied microphone securely into the jack.
ERROR CHECK SPEAKER	The microphone cannot pick up the measuring tone of the front and rear speakers.	Confirm that the speakers are connected correctly.
		Correct the input level setting of the power amp connected to the speakers.
		Set the microphone correctly.
ERROR CHECK SYSTEM	The surrounding noise level is too high.	Stop your car in a place that is as quiet as possible, and switch off the engine, air conditioner or heater.
		Set the microphone correctly.

Understanding built-in CD player error messages

When problems occur during CD play, an error message may appear on the display. If an error message appears on the display, refer to the table below to see what the problem is and the suggested method of correcting the problem. If the error cannot be corrected, contact your dealer or your nearest Pioneer service center.

Display	Cause	Remedy
ERROR- 00, 44	All tracks are skip tracks.	Replace disc.
ERROR- 11, 12, 17, 30	Dirty disc.	Clean disc.
ERROR- 11, 12, 17, 30	Scratched disc.	Replace disc.
ERROR- 12, 17	Unrecorded disc.	Check the disc.
ERROR- 10, 11, 12, 17, 30, A0, B0	Electrical or mechanical problem.	Turn the car ignition ON and OFF, or switch to a different source, then switch back to the CD player.
ERROR- 23	The CD format cannot be played back.	Replace disc.
Can't play	MP3 file cannot be played back.	Switch to other MP3 file.
HEAT	CD player overheated.	Turn off the CD player and wait until the CD player cools down.
No audio	Nothing has been recorded or the CD format cannot be played back.	Replace disc.

Understanding music server error messages

Display	Cause	Remedy
ERROR- 23 SERVER ERROR- 23	Music server's hard disc malfunction.	Repeat operation.
ERROR- 24 SERVER ERROR- 24	Music server malfunction (due to damaged data, etc.)	Turn the car ignition ON and OFF, or switch to a different source, then switch back to the music server.
ERROR- 30, A0, A1, B0 SERVER ERROR- 30, A0, A1, B0	Electrical or mechanical problem.	Turn the car ignition ON and OFF, or switch to a different source, then switch back to the music server.
Can't play	The music data cannot be played back.	Switch to other music data.
Expired	The music data has exceeded the playback limit (playback time or number of plays).	Switch to other music data.
No audio	No recording on music server.	Record tracks on music server.
No PlayList	No playlist file for music data that can be played back in selected playlist mode.	Switch to other playlist mode.
SERVER READ ERROR	Somehow track information was not read in correctly. There is something wrong with the music server.	Turn the car ignition ON and OFF, or switch to a different source, then switch back to the music server.
SERVER WRITE ERROR	Somehow track information or FAT was not written correctly.	Repeat operation.
TEMP	Abnormal temperature inside this product.	Wait until normal operating temperature is restored.

Understanding music server error messages when recording

Display	Cause	Remedy
ERROR- 56	SDMI contravention.	Select another track.
ERROR- 59	You have tried to record more playlist files for digital recordings than the music server can manage.	Erase unwanted playlist files for digital recordings.
ERROR- 5A	You have tried to record more playlist files for analog recordings than the music server can manage.	Erase unwanted playlist files for analog recordings.
ERROR- 5B	You have tried to record more artist playlist files than the music server can manage.	Erase unwanted artist playlist files.
ERROR- 5-	You have tried to record more playlist files for each recording date than the music server can manage.	Erase unwanted playlist files for each recording date.
Can't copy	Trying to copy from a copy protect disc including CD-R	Replace a disc that can be copied (a regular CD).
CD-ROM	Trying to copy from a CD-ROM.	Replace a music CD.
Defect	CD skips three times at same place.	Clean disc.
M.Server full	Insufficient space to record on music server.	Erase unwanted tracks.
No disc	No disc is set in this product.	Insert disc.
NO SIGNAL	You can not enter digital signals into the music server.	Turn the car ignition OFF and then ON, or press RESET button.
PlayList full	You have tried to record more playlist files than the music server can manage.	Erase unwanted playlist files.
Retry	The CD skips.	Clean disc.
SERVER READ ERR	Somehow track information was not read in correctly.	Repeat operation.
SERVER WRITE ERR	Somehow track information or FAT was not written correctly.	Repeat operation.
TEMP	Recording is not possible because of low temperature.	Wait until the temperature of this unit rises.
	Abnormal temperature inside this product.	Wait until normal operating temperature is restored.

Continued overleaf.

Additional Information

Display	Cause	Remedy
Time short	The time remaining on the music server is shorter than the disc or tracks to be recorded.	Erase unwanted tracks.
TOC ERR	The CD's TOC is unreadable.	Replace disc.
Track full	You try to record more than 400 tracks in a single playlist file.	Cancel record standby.

Note:

- Should any other error messages appear, refer to “Understanding music server error messages” on page 75.
- The TOC (Table of Contents) consists of information other than the audio signal—such as the number of recorded tracks, playing time and title—on CD and MD discs, etc.
- The FAT (File Allocation Table) defines the parameters for managing music data and playlist files on the music server and “Memory Stick”, etc.

Understanding “Memory Stick” player error messages

Display	Cause	Remedy
ERROR- 24 STICK ERROR- 24	There is something wrong with the “Memory Stick”.	Replace the “Memory Stick”.
ERROR- 27 STICK ERROR- 27	The “Memory Stick” has been inserted upside-down or back-to-front.	Remove “Memory Stick”, align correctly and reinsert. If message reappears, replace the “Memory Stick”.
ERROR- 30, A0, A1, B0 STICK ERROR- 30, A0, A1, B0	Electrical or mechanical problem.	Turn the car ignition ON and OFF, or switch to a different source, then switch back to the “Memory Stick” player.
ERROR- 55 STICK WRITE ERROR	Somehow the track information was not written correctly.	Repeat operation. If message reappears, replace the “Memory Stick”.
Can't play WARNING- 14	The music data cannot be played back.	Switch to other music data.
Expired	The music data has exceeded the playback limit (playback time or number of plays).	Switch to other music data.
FORMAT ERROR	A “Memory Stick” other than an “MG Memory Stick” is inserted. A “Memory Stick” formatted in such a way as to be unable to be played back in this product is inserted (such as a “Memory Stick” formatted on a PC).	Replace the “MG Memory Stick”. Remove the “Memory Stick” and insert it again. If message reappears, replace the “Memory Stick”.

Display	Cause	Remedy
MS Locked Protected	The erasure prevention switch is set to LOCK.	Cancel the erasure prevention switch.
No audio	A "MG Memory Stick" with no music data on it has been inserted, or a "Memory Stick" other than a "MG Memory Stick" has been inserted.	Insert a "MG Memory Stick" with music data on it.
No Stick	The "Memory Stick" is not inserted.	Insert the "Memory Stick."
Stick full	There is insufficient empty space on the "Memory Stick".	Replace the "Memory Stick" or erase unwanted music data.
STICK READ ERROR	Somehow track information was not read in correctly. There is something wrong with the "Memory Stick".	Remove the "Memory Stick" and insert it again. If message reappears, replace the "Memory Stick".
WARNING- 16	There is no playback permission for music data procured by electronic distribution, such as over the Internet.	Switch to other music data.

Terms

ATRAC3

Short for “Adaptive Transform Acoustic Coding3”. This is an audio compression technology for high-quality and high compression. It is possible to compress music data to about 1/10th the level of a CD, allowing miniaturization of storage media.

Bit rate

This expresses data volume per second, or bps units (bits per second). The higher the rate, the more information is available to reproduce the sound. Using the same encoding method (such as ATRAC3), the higher the rate, the better the sound. (As different encoding methods are used for MP3 and ATRAC3, a simple comparison is impossible.)

ID3 Tag

This is a method of embedding track-related information in a MP3 file. This embedded information can include the track title, the artist’s name, the album title, the music genre, the year of production, comments and other data. The contents can be freely edited using software with ID3 Tag editing functions. Although the tags are restricted to the number of characters, the information can be viewed when the track is played back.

ISO9660 format

This is the international standard for the format logic of CD-ROM folders and files. For the ISO9660 format, there are regulations for the following two levels.

Level 1:

The file name is in 8.3 format (the name consists of up to 8 characters, half-byte English capital letters and half-byte numerals and the “_” sign, with a file-extension of three characters.)

Level 2:

The file name can have up to 31 characters (including the separation mark “.” and a file extension). Each folder contains less than 8 hierarchies.

Extended formats

Joliet:

File names can have up to 64 characters.

Romeo:

File names can have up to 128 characters.

m3u

Playlists created using the “WINAMP” software have a playlist file extension (.m3u).

MagicGate

Data recorded on a “MagicGate Memory Stick (MG Memory Stick)” is encrypted using copyright protection technology and can be mutually authenticated with “MG Memory Stick” compatible equipment. A “MG Memory Stick” can only be used to record and playback when there is verification between the “MG Memory Stick” and the compatible equipment.

“MagicGate Memory Stick”

This is the name used for a “Memory Stick” that uses the “MagicGate” copyright protection technology. This is an IC recording media for recording and playback of music and other data requiring copyright protection technology.

“Memory Stick”

This is a compact, light-weight IC recording medium. The “Memory Stick” is a regular “Memory Stick” without the copyright protection technology used in the “MagicGate Memory Stick.” The “Memory Stick” can be used to record image and audio data, etc. with “Memory Stick” compatible equipment. Different types of data can be recorded on a single “Memory Stick.”

MP3

MP3 is short for MPEG Audio Layer3. It is an audio compression standard set by a working group (MPEG) of the ISO (International Standards Organization). MP3 is able to compress audio data to about 1/10th the level of a conventional disc.

Multi-session

Multi-session is a recording method that allows additional data to be recorded later. When recording data on a CD-ROM, CD-R or CD-RW, etc., all data from beginning to end is treated as a single unit or session. Multi-session is a method of recording more than 2 sessions in one disc.

Packet write

This is a general term for a method of writing on CD-R, etc. at the time required for a file, just as is done with files on floppy or hard discs.

SCMS

SCMS is short for Serial Copy Management System. This is a serial copy management system developed to stop serial copying (copying of copies) of music, including copying of music recorded digitally from CDs etc. to a hard disk (music server).

SDMI

SDMI is short for Secure Digital Music Initiative. In order to develop a uniform system of copyright protection technology that can be used around the world, more than about 130 companies and organization representing the recording, computer and consumer electronics industries have created a form. The objective is to prevent illegal use of music data and to promote the development of legitimate music distribution services. The “MagicGate” copyright protection technology is standard based on SDMI regulations.

VBR

VBR is short for Variable Bit Rate. Generally speaking CBR (Constant Bit Rate) is more widely used. But to flexibly adjust the bit rate according to the needs of audio compression, it is possible to achieve compression priorities sound quality.

Specifications

General

Power source 14.4 V DC (10.8 – 15.1 V allowable)
Grounding system Negative type
Max. current consumption 10.0 A
Dimensions

(DIN) (chassis) 178 (W) × 50 (H) × 155 (D) mm
[7 (W) × 2 (H) × 6-1/8 (D) in.]
(nose) 188 (W) × 58 (H) × 37 (D) mm
[7-3/8 (W) × 2-1/4 (H) × 1-1/2 (D) in.]
(D) (chassis) 178 (W) × 50 (H) × 160 (D) mm
[7 (W) × 2 (H) × 6-1/4 (D) in.]
(nose) 170 (W) × 46 (H) × 32 (D) mm
[6-3/4 (W) × 1-3/4 (H) × 1-1/4 (D) in.]

Weight

(main body) 1.9 kg (4.2 lbs.)
(power box) 0.2 kg

Audio/DSP

Continuous power output is 22 W per channel min. into 4 ohms, both channels driven 50 to 15,000 Hz with no more than 5% THD.

Maximum power output 50 W × 4
Load impedance 4 Ω (4 – 8 Ω allowable)
Preout maximum output level/
output impedance 2.2 V/1 kΩ
Loudness contour +10 dB (100 Hz), +6.5 dB (10 kHz)
(volume: –30 dB)

Equalizer (13-Band Graphic Equalizer)

Frequency 50/80/125/200/315/500/800 Hz
1.25/2/3.15/5/8/12.5 kHz
Equalization range ±12 dB (2 dB)

Auto Equalizer (Front & Rear & Subwoofer 13-Band Graphic)

Frequency 50/80/125/200/315/500/800 Hz
1.25/2/3.15/5/8/12.5 kHz
Equalization range +6 — –12 dB (2 dB)

Network

HPF (Front/Rear)

Frequency 50/63/80/100/125 Hz
Slope –12 dB/oct.

Subwoofer output

Frequency 50/63/80/100/125 Hz
Slope –18 dB/oct.
Gain –24 dB — +6 dB (1 dB)
Phase Normal/Reverse

CD player

System Compact disc audio system
Usable discs Compact disc
Signal format Sampling frequency: 44.1 kHz
Number of quantization bits: 16; linear
Frequency characteristics 5 – 20,000 Hz (±1 dB)
Signal-to-noise ratio 94 dB (1 kHz) (IHF-A network)
Dynamic range 92 dB (1 kHz)
MP3 decoding MPEG 1 Audio Layer 3
Number of channels 2 (stereo)

HDD

HDD quantity 10 GB
Codec ATRAC3
Frequency characteristics 20 – 20,000 Hz (±1 dB)
Average seek time 13 msec.

“Memory Stick” player

Type MagicGate Memory Stick
Decoding ATRAC3
Frequency characteristics 20 – 20,000 Hz (±1 dB)

FM tuner

Frequency range	87.9 – 107.9 MHz
Usable sensitivity	9 dBf (0.8 μ V/75 Ω , mono, S/N: 30 dB)
50 dB quieting sensitivity	15 dBf (1.5 μ V/75 Ω , mono)
Signal-to-noise ratio	70 dB (IHF-A network)
Distortion	0.3% (at 65 dBf, 1 kHz, stereo)
Frequency response	30 – 15,000 Hz (\pm 3 dB)
Stereo separation	40 dB (at 65 dBf, 1 kHz)
Selectivity	70 dB (2ACA)
Three-signal intermodulation (desired signal level)	30 dBf (two undesired signal level: 100 dBf)

AM tuner

Frequency range	530 – 1,710 kHz (10 kHz)
Usable sensitivity	18 μ V (S/N: 20 dB)
Selectivity	50 dB (\pm 10 kHz)

Note:

- Specifications and design are subject to modification without notice for the sake of improvements.



PIONEER CORPORATION

4-1, MEGURO 1-CHOME, MEGURO-KU, TOKYO 153-8654, JAPAN

PIONEER ELECTRONICS (USA) INC.

P.O. Box 1540, Long Beach, California 90801-1540, U.S.A.

TEL: (800) 421-1404

PIONEER EUROPE NV

Haven 1087, Keetberglaan 1, B-9120 Melsele, Belgium

TEL: (0) 3/570.05.11

PIONEER ELECTRONICS ASIACENTRE PTE. LTD.

253 Alexandra Road, #04-01, Singapore 159936

TEL: 65-472-1111

PIONEER ELECTRONICS AUSTRALIA PTY. LTD.

178-184 Boundary Road, Braeside, Victoria 3195, Australia

TEL: (03) 9586-6300

PIONEER ELECTRONICS OF CANADA, INC.

300 Allstate Parkway, Markham, Ontario L3R 0P2, Canada

TEL: (905) 479-4411

PIONEER ELECTRONICS DE MEXICO, S.A. de C.V.

San Lorenzo 1009 3er. Piso Desp. 302

Col. Del Valle Mexico, D.F. C.P. 03100

TEL: 5-688-52-90

Published by Pioneer Corporation.

Copyright © 2001 by Pioneer Corporation.

All rights reserved.

Publication de Pioneer Corporation.

Copyright © 2001 Pioneer Corporation.

Tous droits de reproduction et de traduction réservés.

DEH-P90HDD

This product conforms to CEMA cord colors.
Le code de couleur des câbles utilisé pour ce produit est conforme à CEMA.



Printed in Japan
Imprimé au Japon
<CRD3473-A> UC

<KMMUF/01K00000>

Connecting the Units

Note:

- This unit is for vehicles with a 12-volt battery and negative grounding. Before installing it in a recreational vehicle, truck, or bus, check the battery voltage.
- To avoid shorts in the electrical system, be sure to disconnect the \ominus battery cable before beginning installation.
- Refer to the owner's manual for details on connecting the power amp and other units, then make connections correctly.
- Secure the wiring with cable clamps or adhesive tape. To protect the wiring, wrap adhesive tape around them where they lie against metal parts.
- Route and secure all wiring so it cannot touch any moving parts, such as the gear shift, handbrake, and seat rails. Do not route wiring in places that get hot, such as near the heater outlet. If the insulation of the wiring melts or gets torn, there is a danger of the wiring short-circuiting to the vehicle body.
- Don't pass the yellow lead through a hole into the engine compartment to connect to the battery. This will damage the lead insulation and cause a very dangerous short.
- Do not shorten any leads. If you do, the protection circuit may fail to work when it should.
- Never feed power to other equipment by cutting the insulation of the power supply lead of the unit and tapping into the lead. The current capacity of the lead will be exceeded, causing overheating.
- When replacing fuse, be sure to use only fuse of the rating prescribed on the fuse holder.
- Since a unique BPTL circuit is employed, never wire so the speaker leads are directly grounded or the left and right \ominus speaker leads are common.
- If the RCA pin jack on the unit will not be used, do not remove the caps attached to the end of the connector.
- Speakers connected to this unit must be high-power types with minimum rating of 50 W and impedance of 4 to 8 ohms. Connecting speakers with output and/or impedance values other than those noted here may result in the speakers catching fire, emitting smoke, or becoming damaged.
- When this product's source is switched ON, a control signal is output through the blue/white lead. Connect to an external power amp's system remote control or the car's Auto-antenna relay control terminal (max. 300 mA 12 V DC). If the car features a glass antenna, connect to the antenna booster power supply terminal.

- When an external power amp is being used with this system, be sure not to connect the blue/white lead to the amp's power terminal. Likewise, do not connect the blue/white lead to the power terminal of the auto-antenna. Such connection could cause excessive current drain and malfunction.
- To avoid short-circuiting, cover the disconnected lead with insulating tape. Especially, insulate the unused speaker leads without fail. There is a possibility of short-circuiting if the leads are not insulated.
- To prevent incorrect connection, the input side of the IP-BUS connector is blue, and the output side is black. Connect the connectors of the same colors correctly.
- If this unit is installed in a vehicle that does not have an ACC (accessory) position on the ignition switch, the red lead of the unit should be connected to a terminal coupled with ignition switch ON/OFF operations. If this is not done, the vehicle battery may be drained when you are away from the vehicle for several hours. (Fig. 1)

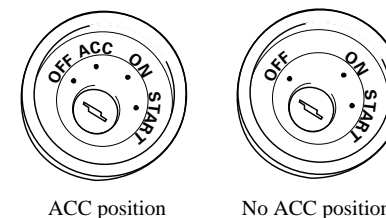

Fig. 1

- The black lead is ground. Please ground this lead separately from the ground of high-current products such as power amps. If you ground the products together and the ground becomes detached, there is a risk of damage to the products or fire.
- Cords for this product and those for other products may be different colors even if they have the same function. When connecting this product to another product, refer to the supplied Installation manuals of both products and connect cords that have the same function.

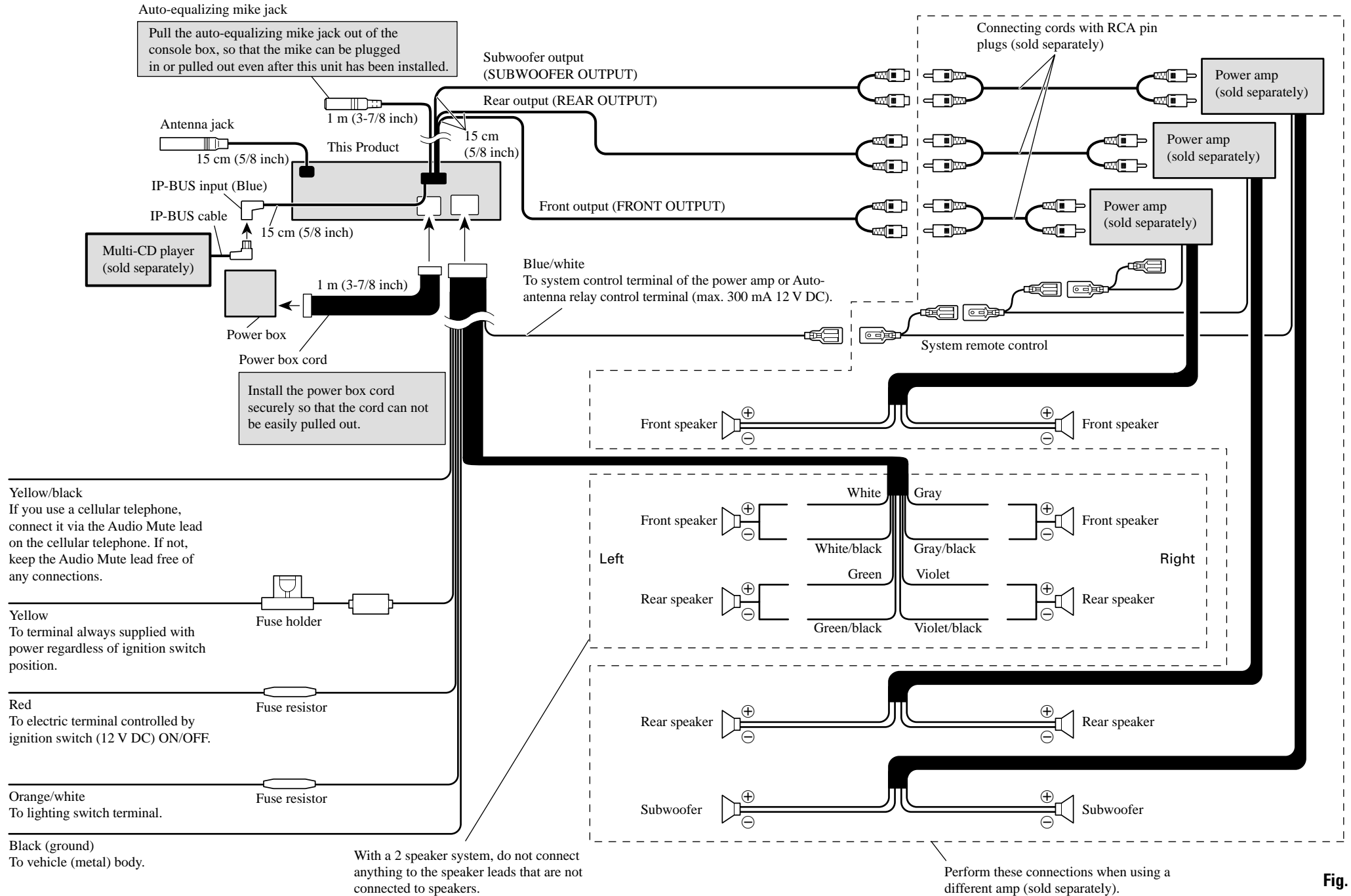

Fig. 2

Installation

Note:

- Before finally installing the unit, connect the wiring temporarily, making sure it is all connected up properly, and the unit and the system work properly.
- Use only the parts included with the unit to ensure proper installation. The use of unauthorized parts can cause malfunctions.
- Consult with your nearest dealer if installation requires the drilling of holes or other modifications of the vehicle.
- Install the unit where it does not get in the driver's way and cannot injure the passenger if there is a sudden stop, like an emergency stop.
- The semiconductor laser will be damaged if it overheats, so don't install the unit anywhere hot — for instance, near a heater outlet.
- If installation angle exceeds 30° from horizontal, the unit might not give its optimum performance. (Fig. 3)

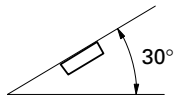
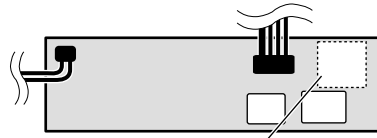

Fig. 3

- This unit and the GPS antenna of the navigation unit should be set as far apart as possible. If they are too close, this unit and the navigation unit may not operate correctly.
- Do not install the power box near doors where rainwater could splash onto it.
- As the power box can heat up, it should never be installed in the following locations:
 - where it could come into contact with car wiring or equipment
 - where it would easily come into contact with passengers.

- This unit must be installed after pulling the auto-equalizing mike jack out of the console box, so that the mike can be plugged in or pulled out even after this unit has been installed.
- The cords must not cover up the area shown in Fig. 2. This is so the amplifiers can radiate freely.



Do not close this area.

Fig. 4

DIN Front/Rear-mount

This unit can be properly installed either from “Front” (conventional DIN Front-mount) or “Rear” (DIN Rear-mount installation, utilizing threaded screw holes at the sides of unit chassis). For details, refer to the following illustrated installation methods.

DIN Front-mount

Installation with the rubber bush (Fig. 5)

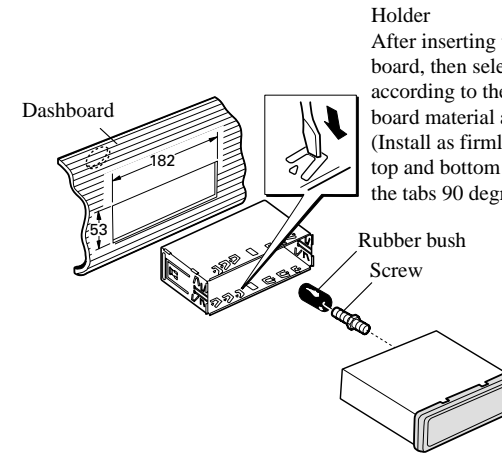

Holder

After inserting the holder into the dashboard, then select the appropriate tabs according to the thickness of the dashboard material and bend them. (Install as firmly as possible using the top and bottom tabs. To secure, bend the tabs 90 degrees.)

Fig. 5

Installation without the rubber bush (Fig. 6)

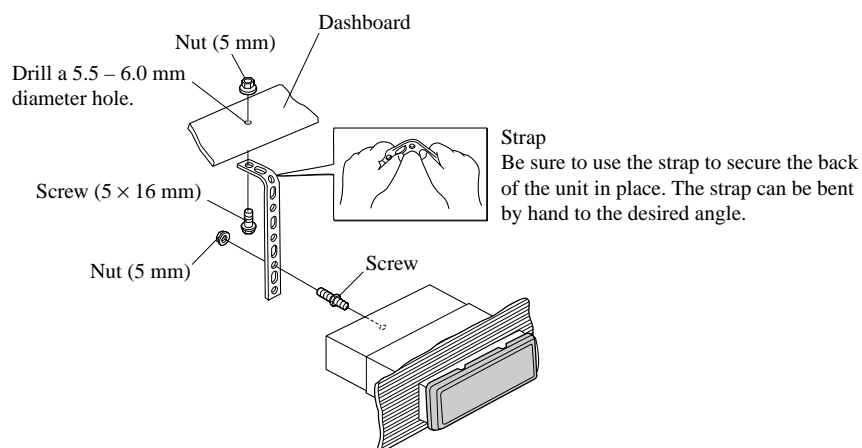

Fig. 6

Removing the Unit (Fig. 7) (Fig. 8)

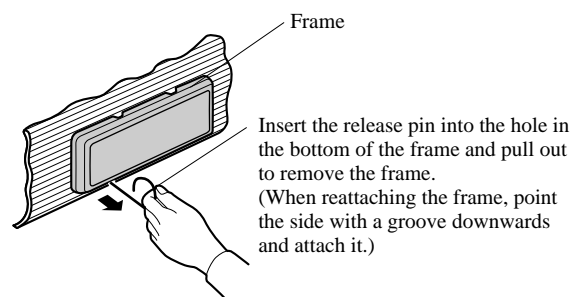

Fig. 7

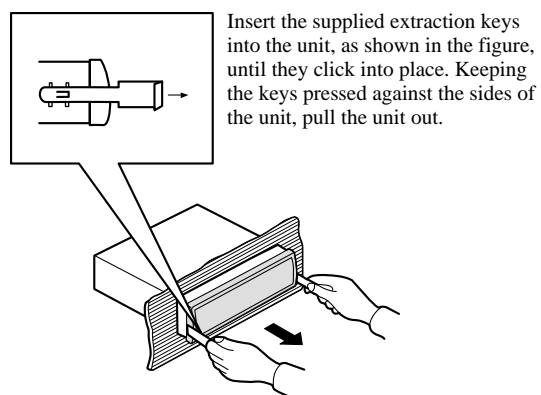

Fig. 8

DIN Rear-mount

Installation using the screw holes on the side of the unit

1. Remove the frame. (Fig. 9)

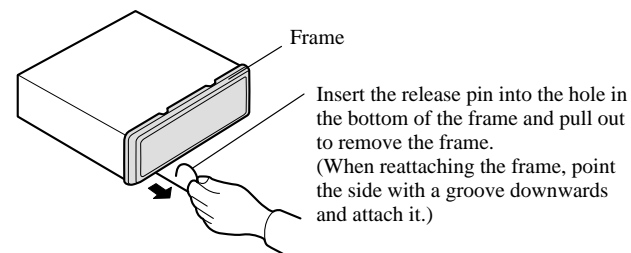

Fig. 9

2. Fastening the unit to the factory radio mounting bracket. (Fig. 10) (Fig. 11)

Select a position where the screw holes of the bracket and the screw holes of the head unit become aligned (are fitted), and tighten the screws at 2 places on each side. Use either binding screws (5 x 8 mm) or flush surface screws (5 x 8 mm), depending on the shape of the screw holes in the bracket.

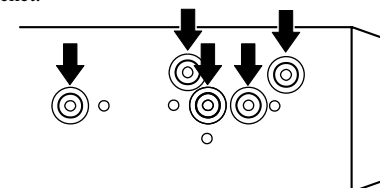

Fig. 10

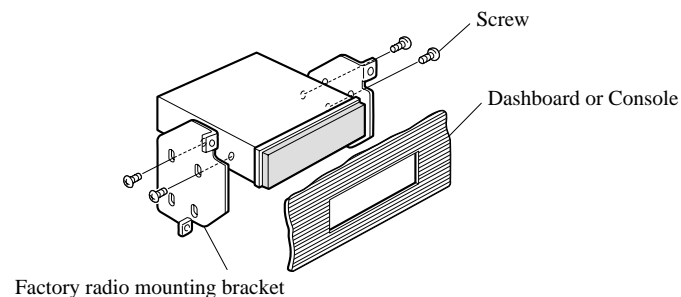
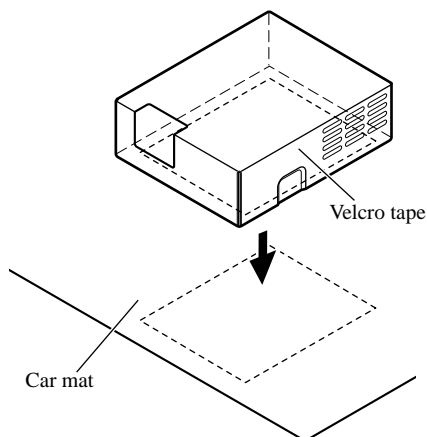

Fig. 11

Installing the power box (Fig. 12)

The power box has velcro tape on the underside to secure it to the car mat.

- Wipe the surface thoroughly before affixing the velcro tape.

**Fig. 12****About the fixing screws for the front panel (Fig. 13)**

If you do not operate the Detaching and Replacing the Front Panel Function, use the supplied fixing screws and fix the front panel to this unit.

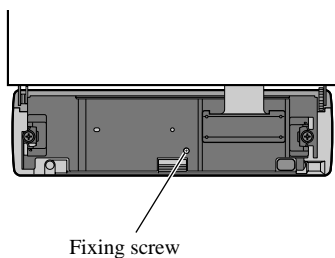
**Fig. 13**

⚠ WARNING

- Avoid installing this unit in such a location where the operation of safety devices such as airbags is prevented by this unit. Otherwise, there is a danger of a fatal accident.
- Avoid installing this unit in such a location where the operation of the steering wheel and the gearshift lever may be prevented. Otherwise, it may result in a traffic accident.

⚠ CAUTION

- Installation of this unit requires specialized skills and experience. Installation of this unit should be entrusted to a dealer from whom you purchased this unit.
- Install this unit using only the parts supplied with this unit. If other parts are used, this unit may be damaged or could dismount itself, which leads to an accident or trouble.
- Install this unit as required by this manual. Failure to do so may cause an accident.
- Do not install this unit near the doors where rain-water is likely to be spilled on the unit. Incursion of water into the unit may cause smoke or fire.

⚠ WARNING

- Fix this unit securely to the steering wheel with the belt attached to the unit. If this unit is loose, it disturbs driving stability, which may result in a traffic accident.
- Do not attach this unit to the outer circumference of the steering wheel. Otherwise, it disturbs driving stability, causing a traffic accident. Always attach this unit to the inner circumference of the steering wheel as shown. (Fig. 14)

Note:

- Do not install this unit in such a place as may obstruct the driver's view.
- Since interior layout differs depending on the type of vehicle, the ideal installation location for the unit also differs. When installing the unit, select a location that assures optimum transmission of signals from the unit to the car stereo.

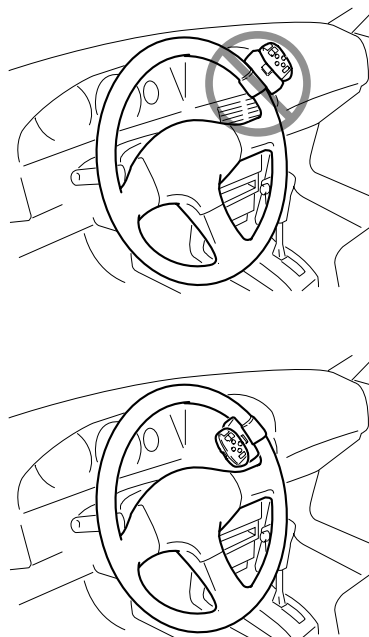

Fig. 14

Installing the Unit on a Left-Hand-Drive Car

Note:

- When the unit is installed on a right-hand-drive car, the horizontal positions are inverted.

1. Secure inner holder to the inner circumference of the steering wheel with belt. (Fig. 15)

- Fit the inner holder to the steering wheel so that the arrow-marked side faces the driver as shown below.

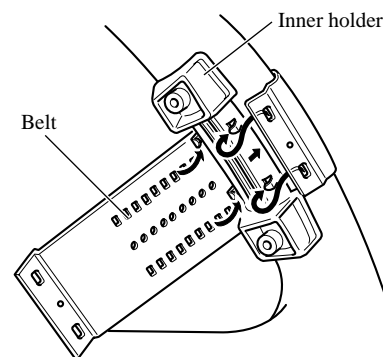

Fig. 15

2. Cut the extra portion of the belt at the center of the inner holder. (Fig. 16)

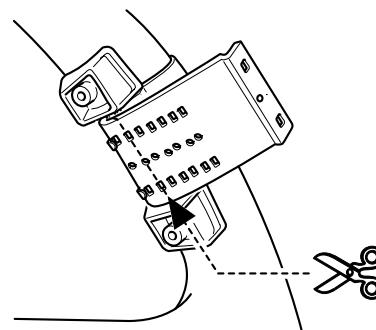

Fig. 16

3. Install outer holder on the inner holder and secure with screws. (Fig. 17)

- Tighten the screws with the supplied hexagonal wrench.

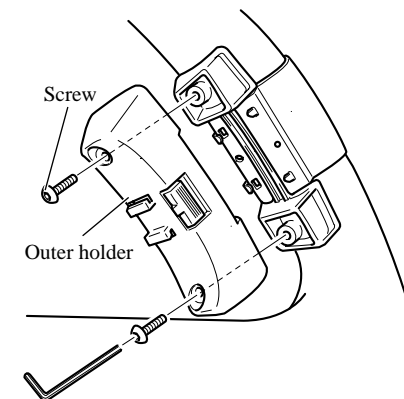

Fig. 17

4. Install the remote control unit in the holder. (Fig. 18)

- When removing the remote control unit from the holder, move the corrugated release section toward the steering wheel and slide the remote control unit toward you.

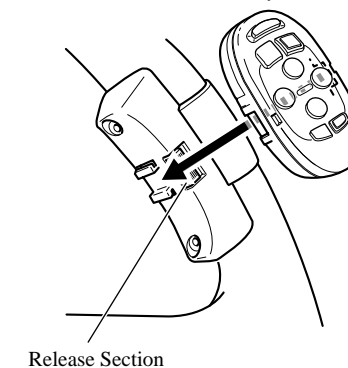

Fig. 18

About the demo mode

This product features two demonstration modes. One is the reverse mode and the other is the feature demo mode.

Reverse mode

If you do not carry out an operation within about 30 seconds, screen indications will start to reverse, and then continue reversing every 10 seconds. Pressing the button 5 when power to this product is switched off while the ignition switch is set to ACC or ON cancels the reverse mode. Press the button 5 again to start the reverse mode.

Feature demo

The feature demo automatically starts when power to this product is switched off while the ignition switch is set to ACC or ON. Pressing the button 6 during feature demo operation cancels the feature demo mode. Press the button 6 again to start the feature demo mode. Remember that if the feature demo continues operating when the car engine is switched OFF, it may drain battery power.

Note:

- The red lead (ACC) of this product should be connected to a terminal coupled with ignition switch ON or OFF operations. If this is not done, the vehicle battery may be drained.
- When the source is off, you can check the location of “5” and “6” by turning on the feature demo.

Information for updating the Gracenote CDDB database

Thank you for buying this Pioneer product.

You can update the built-in Gracenote CDDB database of this product.

For details, please go to the Pioneer homepage.

URL: <http://www.pioneer.co.jp/product-e/consumer/car-hdd/download/index.html>

As the model No. and the serial No. of this product are required for downloading, you should save this information carefully.

Information sur la mise à niveau de la base de données Gracenote CDDB

Merci d'avoir acheté ce produit Pioneer.

Vous pouvez effectuer une mise à niveau de la base de données Gracenote CDDB incorporée à ce produit.

Pour les détails, visitez notre site Pioneer.

URL: <http://www.pioneer.co.jp/product-e/consumer/car-hdd/download/index.html>

Comme vous aurez besoin du n° de modèle et du n° de série de ce produit pour le téléchargement, conservez cette information précieusement.

Información para actualizar la base de datos CDDB de Gracenote

Gracias por la compra de este producto Pioneer.

Usted puede actualizar la base de datos CDDB de Gracenote incorporada a este producto.

Para los detalles, consulte la página principal de Pioneer.

URL: <http://www.pioneer.co.jp/product-e/consumer/car-hdd/download/index.html>

Como para la descarga necesitará el N° de modelo y el N° de serie de este producto, tenga a bien guardar esta información.

Informação para atualização da base de dados Gracenote CDDB

Obrigado por adquirir este produto Pioneer.

Você pode atualizar a base de dados Gracenote CDDB incorporada neste produto.

Para maiores detalhes, vá à página da Pioneer na Internet.

URL: <http://www.pioneer.co.jp/product-e/consumer/car-hdd/download/index.html>

Como o número do modelo e número de série deste produto são necessários para o carregamento dos dados, você deve guardar esta informação com cuidado.

Gracenote CDDB معلومات بخصوص تحديث قاعدة البيانات

شكراً على شرائك لمنتج بايونير هذا.

يمكنك تحديث قاعدة البيانات المركب داخلياً Gracenote CDDB لهذا المنتج.
بخصوص التفاصيل، يرجى الرجوع الى موقع بايونير على الانترنت.

URL: <http://www.pioneer.co.jp/product-e/consumer/car-hdd/download/index.html>

عند القيام بالتحميل فإنه يتطلب معرفة رقم الموديل والرقم التسلسلي لهذا المنتج، يجب عليك القيام بحفظ هذه المعلومات بحرص.

Serial No./N° de série/

N° de serie/Número de série/الرقم التسلسلي



PIONEER ELECTRONICS (USA) INC. - PIONEER ELECTRONICS OF CANADA, INC.
(PA) (POC)

LIMITED WARRANTY

WARRANTY VALID ONLY IN COUNTRY OF PRODUCT PURCHASE

WARRANTY PERIOD

For the period specified below from date of original retail purchase (the warranty period) from an authorized Pioneer dealer, Pioneer Electronics (USA) Inc. (PA), and Pioneer Electronics Of Canada, Inc. (POC), warrant that products distributed by PA in the U.S.A., and by POC in Canada that fail to function properly under normal use due to a manufacturing defect when installed and operated according to the owner's manual enclosed with the unit will be repaired or replaced with a unit of comparable value, at the option of PA or POC, without charge to you for parts or actual repair work. Parts supplied under this warranty may be new or rebuilt at the option of PA or POC.

The warranty period for retail customers who rent the product commences upon the date product is first put into use (a) during the rental period or (b) retail sale, whichever occurs first.

The warranty does not cover any product which is used in any trade or business, or in an industrial or commercial application.

PRODUCT

WARRANTY PERIOD
PARTS LABOR

Car Stereo ProductsONE YEAR ONE YEAR

This warranty covers the product during the warranty period whether in the possession of the original owner or any subsequent owner. In the event service is required, the product must be delivered within the warranty period, transportation prepaid, from within the country of purchase as explained in this document. You will be responsible for removal and installation of the product. PA or POC, as appropriate, will pay for the cost of returning the repaired or replacement product to you within the country of purchase.

WHAT'S NOT COVERED

This warranty does not apply to any speaker that has been subjected to power in excess of its published power rating.

This warranty does not cover the cabinet or any appearance item, user attached antennas, any damage to recordings or recording tapes or discs, any damage to the product resulting from alterations, modifications not authorized in writing by PA or POC, accident, misuse or abuse, damage due to lightning or to power surges, subsequent damage from leaking, damaged or inoperative batteries or the use of batteries not conforming to those specified in the owner's manual.

This warranty does not cover the cost of parts or labor which would be otherwise provided without charge under this warranty, obtained from any source other than a PA or POC Authorized Service Company or other designated location. This warranty does not cover defects or damage caused by the use of unauthorized parts or labor, or from improper maintenance.

ALTERED, DEFACED OR REMOVED SERIAL NUMBERS VOID THIS WARRANTY.

YOUR RIGHTS

PA and POC exclude any obligation on their part for incidental or consequential damages related to the failure of products each distributes to function properly under the conditions set forth above.

IN THE U.S.A. - PA LIMITS ITS OBLIGATIONS UNDER ANY IMPLIED WARRANTIES INCLUDING, BUT NOT LIMITED TO, THE IMPLIED WARRANTIES OF MERCHANTABILITY AND FITNESS FOR A PARTICULAR PURPOSE TO A PERIOD NOT TO EXCEED THE WARRANTY PERIOD. NO WARRANTIES SHALL APPLY AFTER THE WARRANTY PERIOD. SOME STATES DO NOT ALLOW LIMITATIONS ON HOW LONG AN IMPLIED WARRANTY LASTS, AND SOME STATES DO NOT ALLOW THE EXCLUSION OR LIMITATION OF INCIDENTAL OR CONSEQUENTIAL DAMAGES, SO THE ABOVE LIMITATIONS OR EXCLUSIONS MAY NOT APPLY TO YOU. THIS WARRANTY GIVES YOU SPECIFIC LEGAL RIGHTS, AND YOU MAY HAVE OTHER RIGHTS WHICH MAY VARY FROM STATE TO STATE.

IN CANADA - EXCEPT AS EXPRESSLY PROVIDED HEREIN, THERE ARE NO REPRESENTATIONS, WARRANTIES, OBLIGATIONS OR CONDITIONS, IMPLIED, STATUTORY OR OTHERWISE, APPLICABLE TO THIS PRODUCT.

TO OBTAIN SERVICE CAR STEREO PRODUCTS (EXCEPT CAR SPEAKERS SOLD IN THE U.S.A. ONLY)

PA and POC have appointed a number of Authorized Service Companies throughout the U.S.A. and Canada should your product ever require service. To receive warranty service you will need to present your sales receipt or, if rented, your rental contract showing place and date of original owner's transaction.

Should it become necessary to ship the unit you will need to package the product carefully and send it, transportation prepaid by a traceable, pre-insured method, to an Authorized Service Company. Carefully package the product using adequate padding material to prevent damage in transit. The original container is ideal for this purpose. Include in the package your name, address, telephone number where you can be reached during business hours, a copy of your sales receipt and a detailed description of the problem.

TO OBTAIN SERVICE CAR SPEAKERS SOLD IN THE U.S.A. ONLY

Should your car speaker require service, return defective car speaker to your retail dealer for exchange. To receive warranty service you will need to present your sales receipt showing place and date of original owner's retail purchase. If, for any reason, you cannot exchange the speakers at the selling dealer, call the Customer Service Department as given below.

- ADDITIONAL INFORMATION -

IN THE U.S.A.
For additional information on this warranty, please call or write:

CUSTOMER SERVICE DEPARTMENT
PIONEER ELECTRONICS SERVICE, INC.
P.O. BOX 1760
LONG BEACH, CALIFORNIA 90801
1-800-421-1404

IN THE U.S.A. DO NOT RETURN ANY PRODUCT TO THE ABOVE ADDRESS. IT IS NOT A SERVICE LOCATION.

IN CANADA
Please contact a Pioneer authorized Dealer to find the nearest Pioneer authorized service location. For additional information on this warranty, please call or write:

CUSTOMER SERVICE DEPARTMENT
PIONEER ELECTRONICS OF CANADA, INC.
300 ALLSTATE PARKWAY
MARKHAM, ON L3R 0P2
(905) 479-4411

IN THE U.S.A.

RECORD THE PLACE AND DATE OF PURCHASE FOR FUTURE REFERENCE

FOR PRODUCT INFORMATION, TO PURCHASE REPLACEMENT PARTS OR TO LOCATE AN AUTHORIZED SERVICE COMPANY
CALL: 1-800-421-1404

Model No. _____ Serial No. _____ Purchase Date _____
Purchased From _____



PIONEER ELECTRONICS (USA) INC. - PIONEER ELECTRONIQUES DU CANADA, INC.
(PA) (POC)

GARANTIE LIMITÉE
GARANTIE VALIDE SEULEMENT DANS LE PAYS OU LE PRODUIT A ÉTÉ ACHETÉ

LA PÉRIODE DE GARANTIE

Pour la période précisée ci-après, à partir de la date originale d'achat au détail (la période de garantie) d'un vendeur autorisé Pioneer, les compagnies Pioneer Electronics (USA) Inc., (PA), et Pioneer Electroniques du Canada, Inc., (POC), garantissent que les Produits distribués par PA aux États-Unis et par POC au Canada qui présenteraient des défauts de fonctionnement lors l'usage normal et quand installés et opérés selon les instructions fournies au consommateur avec les appareils; que ces produits effectés par des défauts de manufacture seront donc réparés ou remplacés par une unité de valeur comparable, (au choix de PA ou POC) sans frais pour les pièces et le temps de travail. Les pièces fournies selon cette garantie peuvent être neuves ou refaites au choix de PA ou POC.

La période de garantie pour les clients-détaillants qui louent les produits commence à la date où le produit est d'abord mis en usage: a) pendant la période de location b) au moment de la vente au détail; selon la première éventualité.
Cette garantie ne couvre aucun produit qui serait utilisé sous forme d'échange d'affaires ou pour des usages de type commercial ou industriel.

LE PRODUIT

Système audio pour l'auto _____

Garantie sur pièces

un an

Temps de travail

un an

Cette garantie sur les produits sera honorée durant sa durée entière qu'elle soit entre les mains du propriétaire original ou d'un propriétaire subséquent. Advenant un cas où le service après vente requis, le produit devra être livré au cours de la durée de la garantie et le transport devra être payé au préalable à l'intérieur du pays où le produit a été acheté, et ce, tel qu'expliqué dans ce document. Vous serez responsables du transport et de l'installation du produit alors que PA ou POC, selon le cas, assumeront le coût du renvoi du produit réparé ou remplacé et ce, à l'intérieur du pays où le produit a été acheté.

CE QUI N'EST PAS COUVERT

Cette garantie ne s'applique pas dans le cas de haut-parleurs qui auraient été soumis à des charges de pouvoir excédant les cotes de puissance publiées.

Cette garantie ne couvre pas: les cabinets ou quelq'article de décoration; les antennes attachés de l'utilisateur; quelque dommage que ce soit à des enregistrements ou rubans et disques; quel que dommage sur le produit résultant d'altérations ou de modifications non autorisées par écrit par PA ou POC; quel que dommage causé par des éclairs ou surtensions de courant; les dommages conséquents du coulage; les batteries endommagées ou inopérantes ou l'utilisation de batteries non conformes aux spécifications du manuel d'instructions.

Cette garantie ne couvre pas le coût de pièces ou de temps de travail alloué sans frais par cette garantie et qui aurait été obtenu d'une autre source qu'une compagnie de service autorisée part PA ou POC ou l'un de leur lieu de service désigné. Cette garantie ne couvre pas les défauts ou dommages causés par l'usage de pièces ou par des travaux non autorisés ou par un entretien non approprié.

DES NUMÉROS DE SÉRIE MODIFIÉS, MUTILÉS OU ENLEVÉS ANNULERONT CETTE GARANTIE.

VOS DROITS

PA et POC excluent de plus toute obligation de leur part dans le cas de dommages incidents ou conséquents reliés à la défectuosité d'un de leurs produits respectifs et ce, aux conditions établies ci-devant.

AUX ÉTATS-UNIS - PA LIMITE SON OBLIGATION AUX GARANTIES IMPLICITES, Y COMPRIS, MAIS SANS S'Y LIMITER, LES GARANTIES DE COMMERCIALITÉ ET DE BON ÉTAT DE MARCHÉ DANS UN BUT PARTICULIER POUR UN TEMPS NE DÉPASSANT PAS LA PÉRIODE DE GARANTIE. AUCUNE GARANTIE NE S'APPLIQUERA UNE FOIS LA PÉRIODE DE GARANTIE ÉCOULÉE. CERTAINS ÉTATS NE PERMETTENT PAS DE LIMITATIONS SUR LA DURÉE IMPLICITE D'UNE GARANTIE ET CERTAINS ÉTATS NE PERMETTENT PAS L'EXCLUSION OU LA LIMITATION DE DOMMAGES FORTUITS OU CONSÉQUENTS. IL SE PEUT DONC QUE LES LIMITATIONS ET EXCLUSIONS CI-DESSUS NE VOUS CONCERNENT PAS. CETTE GARANTIE VOUS ASSURE DES DROITS LÉGAUX PRÉCIS ET VOUS POUVEZ BÉNÉFICIER D'AUTRES DROITS QUI PEUVENT VARIER D'UN ÉTAT À L'AUTRE.

AU CANADA - A L'EXCEPTION DES CLAUSES STIPULÉES DANS CE DOCUMENT, IL N'Y A AUCUNE REPRÉSENTATION, GARANTIE, OBLIGATION OU CONDITION IMPLIQUÉES, PRÉVUES OU AUTRE APPLICABLES À CE PRODUIT.

POUR OBTENIR LE SERVICE

SYSTEME AUDIO POUR L'AUTO (EXCEPTÉ LES HAUT-PARLEURS D'AUTO VENDUS SEULEMENT AUX ÉTATS-UNIS)

PA et POC ont désigné un certain nombre de compagnies autorisées de service à travers les États-Unis et le Canada pour vous servir en cas de besoin de réparation. Pour avoir droit à la garantie de service, vous devrez présenter votre reçu d'achat ou de location indiquant le lieu et la date de la transaction avec le propriétaire original.

S'il était nécessaire d'expédier l'unité, vous devrez emballer le produit avec soin (un emballage soigné requiert l'utilisation de matériel d'isolation adéquat pour assurer la protection du produit en cours de livraison. L'emballage original serait l'idéal à cette fin.) et l'envoyer à une compagnie de service autorisée en assumant les frais de transport au préalable.

Vous inclurez dans ce paquet; vos noms, adresse, numéro de téléphone où vous pouvez être joint lors de jours ouvrables, une copie de votre reçu d'achat et une description détaillée du problème.

POUR SERVICE DES HAUT-PARLEURS D'AUTO AUX E.U. SEULEMENT

Si vos haut-parleurs d'auto avaient besoin de réparation, retournez les haut-parleurs défectueux à votre détaillant pour échange.

Pour obtenir ce service garanti, vous devrez présenter votre reçu d'achat indiquant le lieu et la date d'achat au détail original.

Si, pour n'importe quel raison, vous ne pouvez échanger les haut-parleurs au détaillant, appelez le Département de Service à la Clientèle au numéro mentionné plus bas.

INFORMATIONS SUPPLEMENTAIRES

POUR LES USA

Pour avoir des informations additionellen sur la garantie, s'il vous plait appelez ou écrivez à:

CUSTOMER SERVICE DEPARTMENT
PIONEER ELECTRONICS SERVICE, INC.
P.O. BOX 1760
LONG BEACH, CALIFORNIA 90801
1-800-421-1404

**POUR LES E.U. NE RETOURNEZ PAS DE PRODUIT A CETTE ADRESSE,
IL NE S'AGIT PAS D'UN CENTRE DE SERVICE.**

AU CANADA

S.V.P. contacter un détaillant autorisé PIONEER pour connaître le centre de service autorisé PIONEER le plus près. Pour plus d'informations a propos de cette garantie, S.V.P. appelez ou écrivez à:

DEPARTMENT DE SERVICE POUR DES CLIENTS
PIONEER ELECTRONIQUES DU CANADA, INC.
300 ALLSTATE PARKWAY
MARKHAM, ON L3R 0P2
(905) 479-4411

POUR LES USA

ENREGISTREZ LE LIEU ET LA DATE D'ACHAT POUR RÉFÉRENCE ULTÉRIEURE

Pour plus d'information sur les produits ou pour localiser le centre de service autorisé PIONEER S.V.P. appelez le: 1-800-421-1404

Modèle no: _____ No. de série: _____ Date d'achat: _____

Achet de: _____

PRENEZ SOIN DE GARDER CETTE INFORMATION ET VOTRE RECU D'ACHAT DANS UN ENDROIT SUR